

Lucent Technologies
Bell Labs Innovations



Product information begins on page 2.

Lucent and Ascend have merged.

With the Lucent-Ascend merger, customers gain a broader and more powerful portfolio of next-generation data, voice, fax, and video services and products. To access up-to-the-minute information about our products, see page 2.

We also invite you to contact us with your questions directly at: info@ascend.com

Ascend

WHITE PAPER

Ascend MultiVoice Architecture Strategy

From Dial-Tone to Data Tone



Table of Contents

1. Executive Summary	1
2. Introduction	2
Ascend MultiVoice.....	3
Transparent Connectivity.....	4
Access Port Diversity.....	4
Exploiting the Power of Ascend Switches.....	4
Three-phase MultiVoice Roll Out.....	4
Phase One—MultiVoice for IP and Frame Relay.....	4
Phase Two—MultiVoice over ATM.....	5
Phase Three—MultiVoice Platform.....	5
3. Ascend’s MultiVoice Application for the MAX	5
MultiVoice Gateway for the MAX.....	5
MultiVoice Access Manager for the MAX.....	6
4. Ascend Delivers a Complete Solution	7
Powerfull Switches.....	7
Absolute QoS with IP Navigator.....	8
Navis Network and Service Management.....	9
A Complete Ascend Solution	9
5. Ascend Market Leadership	9
6. Ascend MultiVoice Applications	11
7. Summary	15

1. Executive Summary

Traffic carried over packet switched networks is doubling approximately every eight months, while private and public networks are now widely accepted as a solid means of data transport for both corporations and consumers. Companies are migrating their data networks to carrier-provided VPNs, using IP, Frame Relay and ATM as efficient means of transporting voice, video, and data, realizing cost savings and improved performance. Carriers and Internet Service Providers (ISPs) can offer Quality of Service (QoS) guarantees that determine a network's end-to-end network performance and capacity. These Network Service Providers (NSPs) are preparing to utilize these QoS guarantees to offer "toll quality" voice/telephony services using their data networks. This new voice and data network solution is evolving for several reasons:

- Voice and fax communications are currently separate from the corporate data network. The result is inefficient: two incompatible network infrastructures.
- Integration of voice and data traffic on one network will realize savings in network infrastructure, maintenance, and management costs.
- According to a recent CMP survey, over 40% of an organization's long distance costs are attributed to voice, and for the average company, integration of this traffic with their data traffic can realize significant savings.

Ascend is the first company to offer a totally integrated solution for delivering voice and data services over a single data network. Ascend's MultiVoice™ for IP, Frame Relay and ATM is the only product on the market to guarantee IP QoS across the complete connection – from the Access area through the Core of the public network. Using MultiVoice, ISPs and carriers can now transparently integrate services between their circuit switched voice/fax and packet switched ATM, Frame Relay and IP networks. MultiVoice enables a single data network to efficiently and cost-effectively carry voice, fax and data, allowing the NSPs offering the service to guarantee quality and provide transparent telephony to their customers.

2. Introduction

Today, packet switched networks are exceeding Moore's Law: Instead of doubling capacity every 18 months, data networks are experiencing two times the traffic approximately every six months. Private and public data networks are now widely used and accepted in the business community as a preferred means of data transport. This trend is demonstrated by the trend of companies migrate their critical data networks to Intranets and Extranets, using networks and services provided by NSPs.

Carriers and ISPs are combining services to build a packet switched infrastructure that will deliver voice, fax and data, to customers over one network. The motivation for moving to a single data network is simple: both NSPs and their customers can save significantly (in some cases more than 50%) on long distance calls and fax charges by transporting voice and fax integrated in a single network with data traffic.

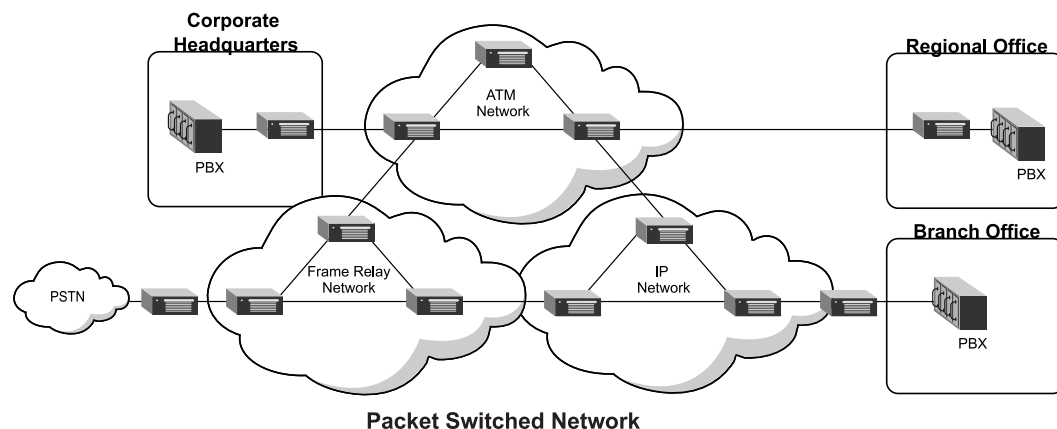

Figure 1 – Companies can reduce the cost of voice/fax communications through integration of voice and fax with data on a single network.

The attractiveness of these savings to corporate and consumer customers is demonstrated by Frost and Sullivan's projection that overall spending on equipment for IP telephony will grow from \$1.9 million in 1996 to almost \$2 billion in 2001. Similarly, Voice over Frame Relay is expected to reach \$800 million in 1999, while voice over ATM is projected to top \$1 billion by the year 2002. This is also reflected in the IDC report that data traffic is growing at the rate of 30 percent per year, while voice demand is constant at 3 percent.

Packet traffic for combined voice and data will continue to grow dramatically in the future for several reasons:

- Packet traffic provides the most efficient transport for multiple capabilities: voice, video, fax and data.
- Multiservice support is now available for IP, Frame Relay, and ATM over the same network.
- Traditional analog connections and familiar operating procedures integrate voice/fax networks with data networks, allowing companies to leverage existing investments in equipment and training.
- Companies can realize cost and performance improvements by migrating from legacy voice networks in favor of integrated data/voice/fax networks.
- Providers can generate significant new revenues by offering low cost regional and/or global integrated voice, fax, and data services.

The key to success in applications for integrated voice/fax/data networks is transparency to the user and to the NSP. Transparency to the user placing a telephone call requires high voice quality, low bandwidth consumption and low end to end delay. Transparency to the NSP requires carrier-quality management, provisioning and billing systems as well as integration with the SS7 carrier signaling Intelligent Network (IN).

Carriers and ISPs are building the infrastructure to delivery high-quality telephone services integrated with data services using new network equipment from Ascend Communications. Incorporating Ascend's MultiVoice into their networks, carriers and ISPs provides a single, comprehensive solution that delivers integrated voice/fax and data traffic with guaranteed QoS for their corporate enterprise customers. Ascend MultiVoice is the industry's only solution that offers totally integrated support across Access and Core equipment, enabling carriers and ISPs to offer guaranteed-quality voice/fax/data services.

Ascend MultiVoice: The First Transparent Integration of Existing Voice Networks with Voice/Fax over IP, ATM, and Frame Relay Networks

Ascend Communication's MultiVoice strategy provides a totally integrated solution for carriers and ISPs to offer combined voice/fax and data networks. MultiVoice includes Voice Over IP (VoIP), Voice Over Frame Relay (VoFR) and Voice Over ATM (VoATM) services. MultiVoice solutions explore the industry-leading strength of Ascend's access products and core switching backbones to provide both carrier-class network management services across the entire network and Absolute QoS guarantees for time-critical voice calls. MultiVoice is transparent to the person placing the call and transparent to the carrier providing the services. Only Ascend's solution enables carriers and ISPs to provide managed, toll-quality carrier-class voice and fax services over their existing and future data networks.

Ascend's MultiVoice architecture provides these capabilities by a unique combination of Ascend's award-winning, industry-leading access and core technologies. These capabilities that are integrated to provide the MultiVoice solution include:

- Multiservice support over IP, Frame Relay and ATM networks
- Toll-quality voice and fax
- Interoperability between switched and packet networks
- The strength of Ascend's installed base:
 - Over 3,500,000 ports installed
 - Products installed in over 100 countries
 - Over 50,000 MAX™ and MAX TNT™ units shipped
 - Strong knowledge and support of signaling protocols worldwide.
- The power of Ascend's switches:
 - Call setup rates up to 8 million calls per busy hour¹ for the Ascend GX 550
 - Support for simultaneous voice and fax applications over IP, Frame Relay and ATM
- Absolute QoS for voice and data over IP, Frame Relay and ATM networks with Ascend's IP Navigator
- Carrier service management with Ascend Navis™, including billing, control, back office services and SS7 network connectivity
- Totally integrated offering for carrier/ISP-provided voice/data networks

¹ Note: A typical central office switch handles about a million calls per hour.

Transparent Connectivity

MultiVoice provides transparent voice/fax services across data networks. Ascend delivers not just carrier-quality voice compression and capabilities, but also provides the full network transport capabilities needed to assure the quality of the call, from the access devices at the edge of the network through the core network backbone. The combination of these capabilities delivers a quality call to the user regardless of the network structure used to transport the call. This lets NSPs use MultiVoice to transport voice across the most cost-effective network structure available.

MultiVoice is transparent to the NSP. A MultiVoice network appears as another switch in the carrier's network and voice traffic can be directed to a MultiVoice-enabled network through the use of standard SS7 carrier signaling. In addition, MultiVoice networks are managed by Ascend's Navis network management software providing full provisioning, management, and billing capabilities from end to end. The NSP thus deals with MultiVoice as another voice path option in their portfolio, using the data networks for voice based on the carrier or ISP's service offerings, economics, or traffic requirements.

Access Port Diversity

The first phase of the MultiVoice release will be integrated into Ascend's MAX and MAX TNT product families. Ascend offers voice as an upgrade to the installed base of access concentrators allowing MultiVoice to exploit the capabilities of these industry-leading products. Access port diversity will enable a port on a MAX or MAX TNT to be interchangeable between data, voice and fax calls. An NSP using MultiVoice could provision a port or set of ports to handle a specific type of call, such as, inbound telephone calls, or could wait for a call to be received to determine the type of call and the services that need to be provisioned in the network for the call.

Exploiting the Power of Ascend Switches

MultiVoice delivers its services by exploiting the power of Ascend's industry-leading Frame Relay and ATM switches: the B-STDx 9000, the CBX 500, and the GX 550. Ascend's switches offer high-capacity connectivity (up to OC-48); high-performance call setup rates (up to 8 million calls per busy hour); Absolute QoS providing total integrated call quality for IP, Frame Relay, and ATM; and Navis for unified network management across all services.

Three-phase MultiVoice Roll Out

MultiVoice services will be provided in three phases: Voice over IP and Frame Relay, Voice over ATM, and Voice Interoperability.

Phase One – MultiVoice for IP and Frame Relay allows service providers and enterprise customers to route voice and fax calls over IP and Frame Relay network structures. MultiVoice for IP and Frame Relay is integrated into the existing MAX 6000 and MAX 400x WAN access switch populated with MultiVoice DSP slot cards. Service providers can upgrade their existing MAX 4000 installed base to deploy MultiVoice capabilities or can use the MAX 6000 for higher-density (up to 96 voice ports) voice connectivity. The MultiVoice VoIP technology can also leverage the Absolute QoS capabilities provided by IP Navigator in Ascend's Frame Relay and ATM core switching products, resulting in toll quality voice comparable to what is currently available via the PSTN.

Phase Two – MultiVoice over ATM will provide compressed voice over ATM integrated into Ascend's Broadband Access products – the SA 100 Broadband Service Unit and the SA 600 Broadband Service Concentrator. Ascend's SA equipment has been providing circuit emulation voice transport over AAL1 for over a year. MultiVoice will enhance this capability by adding compressed voice capabilities to these ATM access products, supporting full voice capabilities that allow efficient ATM link usage, and deliver transparent voice/fax services, including multiple compression rates and algorithms, echo cancellation, silence detection, and comfort noise regeneration.

Phase Three – MultiVoice Platform Integration provides interoperability between IP, Frame Relay, and ATM MultiVoice platforms in addition to SS7 Carrier Signaling services. Carriers and ISPs can utilize the power of Ascend's high-performance IP networks into a single managed infrastructure complete with management, performance and voice/fax interoperability provided by MultiVoice. Integration into the SS7 Carrier Signaling Networks will link MultiVoice calls to conventional carrier call setup and voice networks.

Signaling System No. 7 (SS7)

A key part of realizing transparency to both the user and to the NSP is integration of Ascend's MultiVoice technology with the Signaling System No. 7 (SS7) carrier signaling network. SS7 is an out-of-band signaling protocol that is used to exchange call control information between telephone switching offices. Although generally hidden from the telephone user, the SS7 network provides call setup and teardown call routing, link status and other connection control information. In addition, the SS7 is used by carriers to provide additional services such as credit card validation, 800 number services, and caller line identification.

3. Ascend's MultiVoice Application for the MAX

Ascend's first MultiVoice product offering, MultiVoice for the MAX is a leading solution for Voice-over-IP (VoIP) deployment, delivering MultiVoice capabilities that are highly scalable, integrated and based on the widely-deployed, award-winning Ascend MAX WAN access product family. MultiVoice on the MAX provides carrier-quality voice/fax services over managed IP networks and best-efforts voice transport over unmanaged IP network such as the Internet.

Ascend MultiVoice for the MAX consists of hardware and software components that allow ISPs, carriers, and enterprise customers to add real-time voice transport services to their existing IP backbone network. The initial release of MultiVoice for the MAX includes two components: the MultiVoice Gateway and the MultiVoice Access Manager.

MultiVoice Gateway for the MAX provides the interface between the public switched telephone network (PSTN) and IP or Frame Relay networks. MultiVoice for the MAX is installed by carriers or ISPs as a multi-purpose Access devices, providing data, voice, and fax services at the edge of the network. The MultiVoice for the MAX Gateway performs the following functions:

- Terminates the native PSTN network interfaces (e.g. T1, PRI, E1, and BRI)
- Supports voice codecs which provide different levels of voice compression to reduce data throughput requirements on the packet network
- Supports DTMF tone detection/generation in order to emulate PSTN phone networks
- Supports the ITU-T H.323 protocol stack for Phone-to-Phone and Phone-to-PC connections over the IP network
- Works in conjunction with the MultiVoice Access Manager to establish and terminate calls

MultiVoice Access Manager for the MAX provides network routing functions for connecting voice calls on the IP network. The MultiVoice Access Manager performs the following functions:

- Provides address translation from standard national and international telephone numbers (E.164 numbers or private dialing plan numbers) to IP address and vice-versa.
- Supports user (authentication) and gateway registration.
- Manages the H.323 *zone* for a set of MultiVoice Gateways. A "zone" is defined as a set of H.323 Gateways that are under the control of a specific Access Manager.

The MultiVoice Gateway and Access Manager for the MAX combine to deliver the same degree of network integrity and voice quality that customers have come to expect from their traditional voice carrier. With MultiVoice technology, carrier class voice and fax capabilities are delivered across IP and Frame Relay networks, and at the same time are secure, scalable, manageable, and reliable.

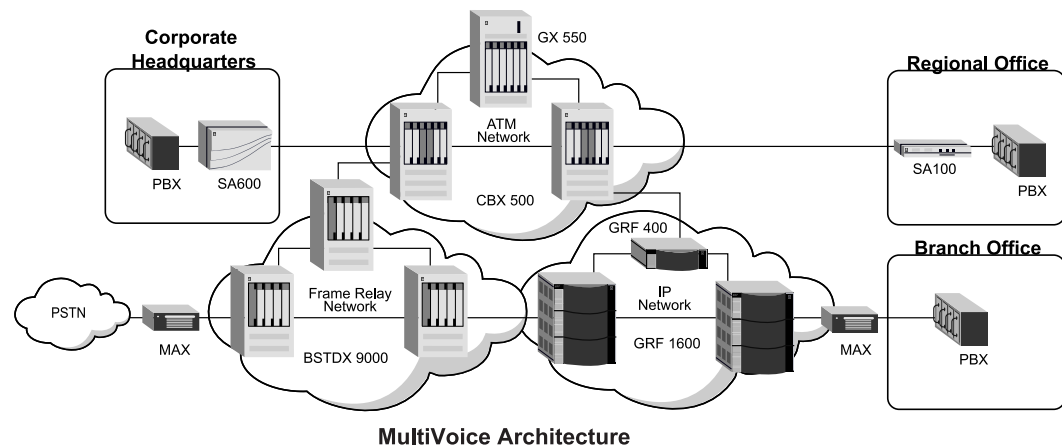

Figure 2 – Carriers and ISPs can now offer mission-critical voice/video or fax to customers as an upgrade to their installed base of Ascend MAX access products.

MultiVoice for the MAX allows an NSP to offer voice, fax and data services with equipment that is designed for NSP environments at a very competitive per-port price. MultiVoice for the MAX provides carriers and ISPs with a high-performance, high-quality, scalable platform to quickly and cost effectively add voice telephone services to their existing network. This allows them to rapidly deploy new service offerings and develop new sources of revenue.

MultiVoice for the MAX lets enterprise customers use the same hardware for both data and voice remote access to the corporate network. In fact, an enterprise can benefit from this solution in several ways. First, it provides a backup for existing voice trunks. Additionally, MultiVoice for the MAX allows MIS managers to support the voice and data needs of small or branch office locations over a single private packet network. MIS managers can deploy a MultiVoice Gateway on the premises on a private basis or as part of a service offering from an NSP. Finally, the enterprise can use the spare capacity on their corporate network to carry voice between PBXs.

4. Ascend Delivers a Complete Solution

MultiVoice is unique to the industry because of its ability to utilize the vast array of technology in Ascend's portfolio. This includes:

- Powerful backbone switches such as the B-STDX, CBX, and GX products
- Absolute QoS by linking Ascend's IP Navigator to access products
- Navis access to core management, provisioning, billing and carrier services

Powerful Switches

Ascend backbone switches offer the industry's only multiservice QoS for wide area networks. Edge routing is performed by the B-STDX 8000/9000 and CBX 500 while core trunk termination and switching is done by the B-STDX 8000/9000 and GX 550. ISPs and carriers gain exceptional benefits by using Ascend switches for backbone MultiVoice applications:

Ascend switches offer industry leading call setup rates:

- Five million calls per busy hour on CBX 500
- Eight million calls per busy hour on GX 550
- Supports up to 500,000 IP routes
- Support for multiservice networks, including simultaneous Voice over IP, Frame Relay, and ATM

Ascend can guarantee "totally integrated" quality voice across multiple switches for IP, Frame Relay, and ATM. Ascend's backbone switch architecture delivers unsurpassed performance, long-term investment protection through compatibility with existing systems, and high scalability—up to 64,000 nodes per network.

Absolute QoS with IP Navigator

Most vendors can only offer either relative or best effort QoS. Ascend's IP Navigator gives providers the capability of delivering multiservice QoS, including the industry's only "Absolute QoS" feature. With Absolute QoS, reserved bandwidth guarantees a path and quality for a call, yet can be utilized by other traffic while no traffic from that call is available. Absolute QoS provides this capability by linking IP Navigator on Ascend switches to the MAX and MAX TNT access equipment through use of the Type of Service (ToS) field in IP to indicate to the switch the required class of service for a call. IP Navigator then uses this information to set up the required service levels across the network.

Using Absolute QoS, carriers and ISPs can determine the appropriate level of QoS for different types of IP service. This capability allows an NSP to provide classes of service for voice and fax – for example, an ISP could offer a premium, toll-quality service priced at one rate and a "best-effort" service priced at a lower rate.

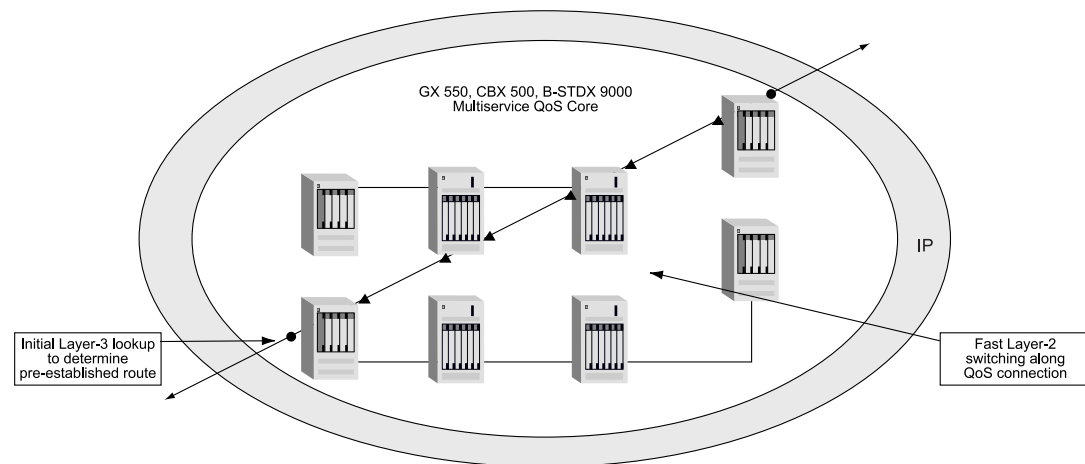

Figure 3 – IP Navigator uses routing information within the IP packet header such as source or destination address or the Type of Service field (ToS), to map critical IP traffic onto a reserved bandwidth path which determines the optimum guaranteed path through the network.

Both IP Navigator and Absolute QoS are based on emerging IETF standards. Ascend's implementation is a precursor to the standard, allowing Ascend to deliver Absolute QoS for voice and fax services while the standard is completed. Ascend is a major participant in the development of these standards and will support the standard implementation when the standards body work is completed.

Navis Network and Service Management

The Navis family of network and service management applications deliver superior management, provide extensive support for discovery and mapping, configuration, fault, and performance management for dial and dedicated portions of the network

Navis also provides multiservice IP, Frame Relay, and ATM configuration and management of Ascend core switches and access products from a single platform. Using Navis, service providers can manage their network according to the way their business infrastructure exists, reducing costs and enabling new service offerings to customers. ISPs and carriers can use Navis for provisioning and billing, along with other carrier services across the complete backbone.

A Complete Ascend Solution

MultiVoice is the ideal solution for enabling voice over data networks, while preserving the service providers' investment in the PSTN. Ascend is the only vendor to offer a total integrated solution, including Absolute QoS quality guarantees, complete management via Navis and total SS7 carrier network integration. MultiVoice architecture leverages Ascend's leading-edge WAN network technologies, voice compression and QoS. The result – a perceived voice experience for customers that rivals the PSTN, while at the same time giving carriers and ISPs a seamless and transparent network architecture for voice/fax/data services.

5. Ascend Market Leadership

World-class carrier and ISP networks depend on Ascend's extensive experience to grow public network facilities. With more than 3,500,000 access concentrator ports at ISP, carrier and corporate enterprise sites worldwide, Ascend equipment is used by the leading international post telegraph and telephone companies to offer Internet access. The MAX WAN access switch family accounts for 50.6 percent of the worldwide market share in access concentrator analog ports, 62.2 percent of access concentrator ISDN PRI ports and 33.6 percent of access concentrator T1 DSOs² Ascend equipment supports more than 30 million Internet connections daily.

Ascend is also the number one provider of Frame Relay and ATM equipment to ISPs world wide, with 42 percent of Frame relay WAN switch connections, and 23 percent of ATM WAN switch connections.³ Over 50,000 MAX, and 10,000 MAX TNT access concentrators have been deployed in ISPs and carriers worldwide. Vertical Systems cites Ascend as the leading provider of Frame Relay equipment to the carrier market, with 21.6 percent share⁴

² Source: Q2 1997 Dell'Oro Report

³ Source: Qugust 1997, Infonetics Research

⁴ Source: August 1997, Vertical Systems Group.

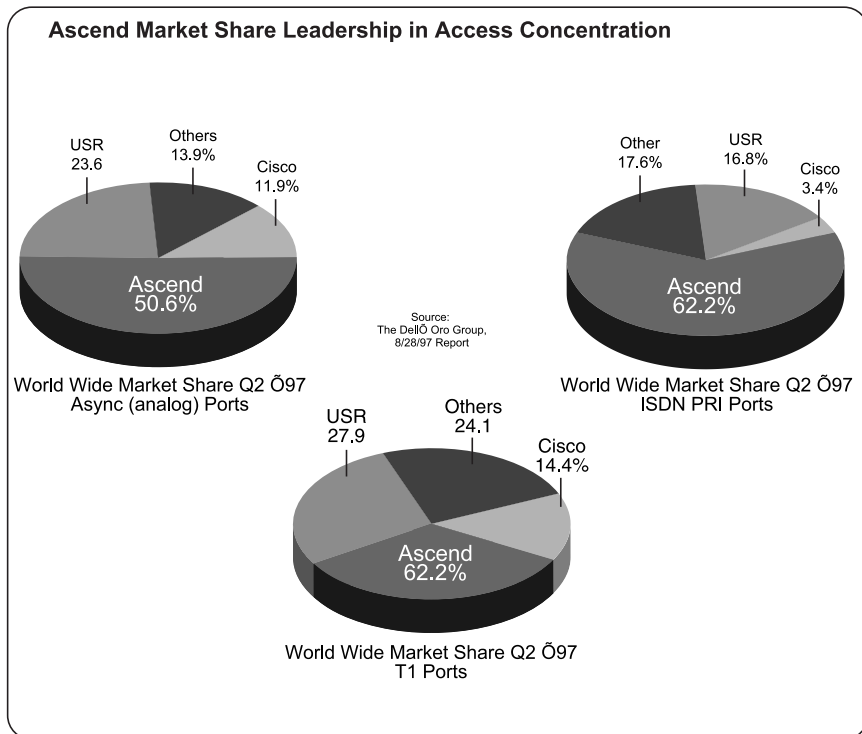
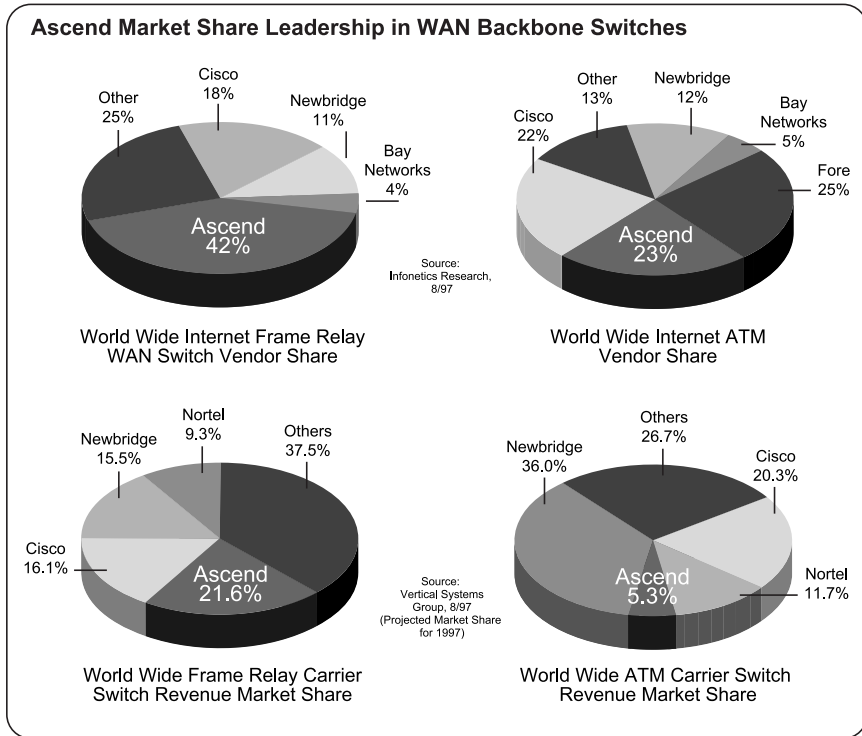

Figure 4 – Ascend's market leadership in WAN backbone switches and access concentration.

Over the past several years, Ascend has worked to integrate product lines in corporate enterprise, ISP and carrier environments. Now they have merged to become the leading provider of WAN solutions, with a strategic focus on next generation voice, video, and fax over data networking. No other competitor offers the breadth of experience in ATM, Frame Relay and IP backbone services as Ascend.

6. Ascend MultiVoice Applications

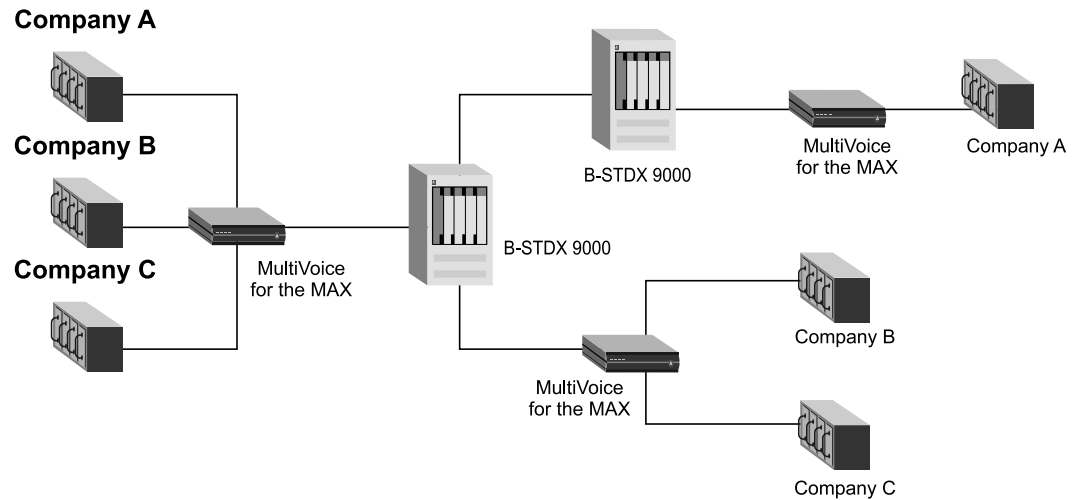

Figure 5 – MultiVoice uses an ISP's exiting IP network to transport voice and fax across corporate Intranet. IP Navigator QoS guarantees delivery and quality.

With MultiVoice, NSPs can now offer new services to business and residential clients. Ascend's Absolute QoS, based on IP Navigator, guarantees the end-to-end quality of the voice call and delivers full provisioning and service management to the ISP. Companies can now utilize the same ISP to provide their Internet access, VPN data network, and voice needs. Individuals can use their ISP to achieve low-cost telephony across the ISP's network

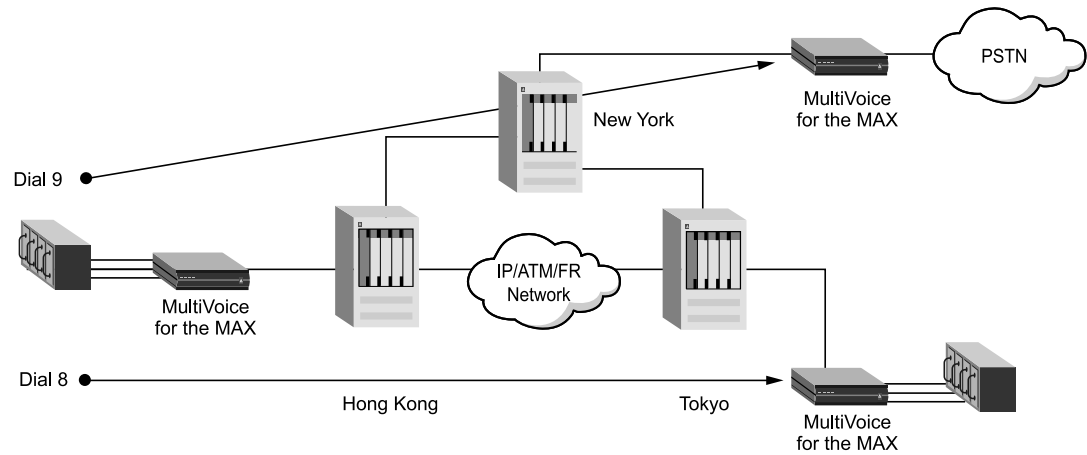

Figure 6 – MultiVoice maximizes IP, ATM, or Frame Relay core switching by allowing companies to attach branch PBXs to a worldwide data network. The result is inexpensive voice or fax routing over the extranet using a single digit dial prefix.

Companies can replace their voice trunks with data trunks and realize the savings of placing voice calls across their Intranet or Extranet. Another example of MultiVoice is the ability to connect PBXs located in distant offices to a common IP, Frame Relay, or ATM core network. For example, if a user picks up their phone in New York and dials 8-7259, the 8 indicates that the call is to be routed to the MultiVoice MAX unit to connect the call to the Tokyo PBX via a packet voice connection. The MAX unit in Tokyo then forwards the 7259 to the PBX in Tokyo, asking it to ring extension 7259.

Extending the WAN

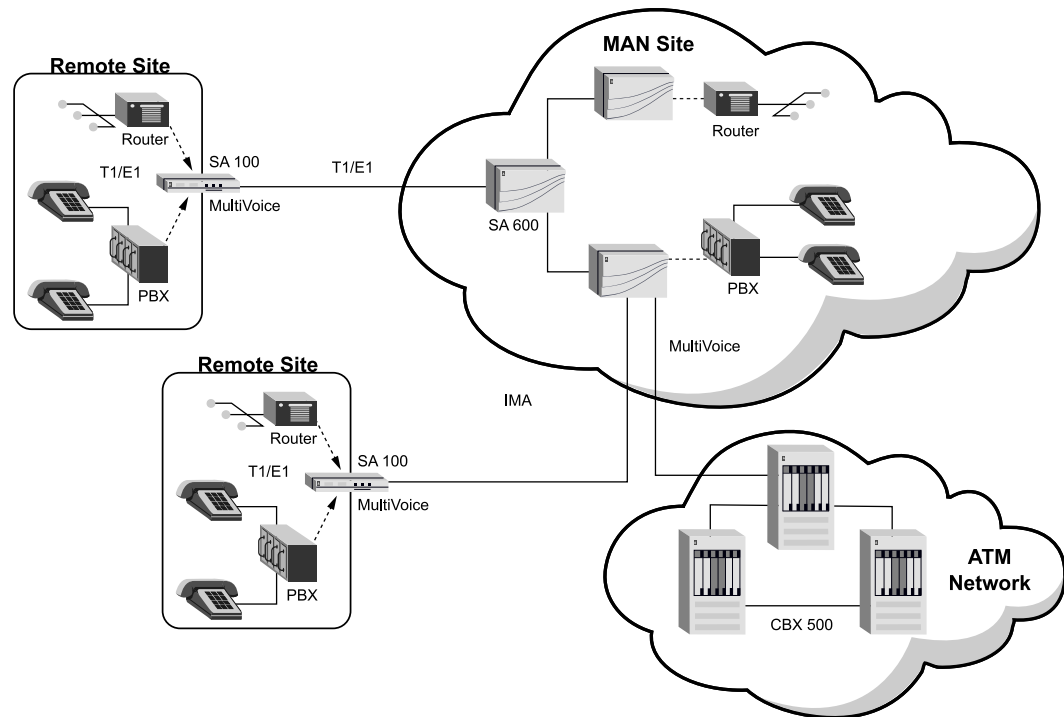

Figure 7 – MultiVoice reduces remote site communications costs by routing voice and fax across the company intranet connection.

Ascend MultiVoice over ATM allows a company to dramatically reduce costs for voice, fax and data traffic carried between its sites. The carrier providing the company's ATM network provides the most efficient transport mechanism for these protocols and efficiently delivers the needed services and capabilities at the branch offices of the enterprises. Users at the remote sites communicate over the internal voice and data networks transparently, with full capabilities offered by the network, yet realize significant cost savings over the conventional approach of parallel and separate voice and data networks.

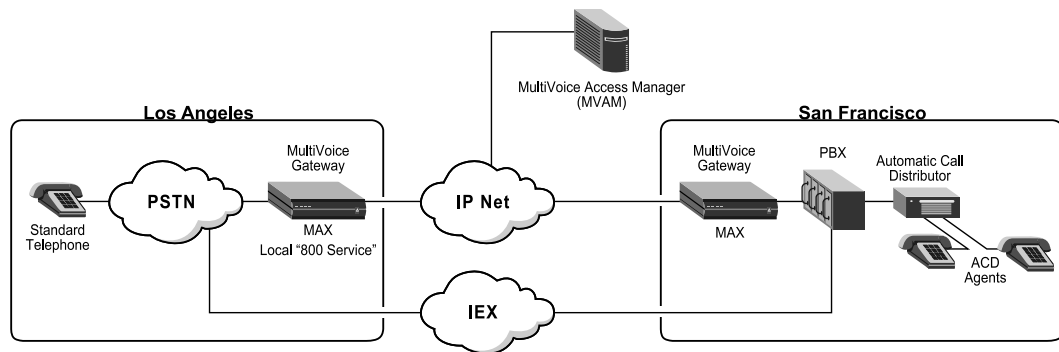

Figure 8 – End users can call a customer service center using an 800-based number, without the customer service center incurring a long distance charge. The call is routed between MultiVoice Gateways, then to a PBX at the customer service center.

The Local "800" application of MultiVoice allows ISPs or other network service providers to lower the cost of customer service, either for their own operation, or for other enterprise customers. Since ISPs already have Point-of-Presence (POP) locations for their existing internet services, they can add MultiVoice Gateway to existing equipment, and publish a local customer service telephone number associated with each POP. This circumvents the long distance calling charges associated with traditional 800 numbers.

Traditional 800-based numbers route the call through the PSTN to a centrally located customer service center. Since the call is toll free, the service center incurs the long distance charge for each call made by the end user.

6. Summary

Ascend's MultiVoice is the only full solution today offering interoperability from core to access, Absolute Quality of Service, carrier-class quality. Ascend Communication's also has a legacy of fast time to market and technical innovation. Carriers, corporations and ISPs receive products that enable them to generate new revenue services, maximize yield, and lower cost of operations. Going forward, Ascend will continue to focus on increasing performance and scalability, managing bandwidth more efficiently, reducing management complexity, and integrating enhanced capabilities across Ascend's market-leading access and core products.

Ascend MultiVoice is a major component in the packet voice equation. It delivers the broadest, most cost-effective solution, which can match network growth and trends, from private to public, or circuit to packet switched. MultiVoice provides carrier-class voice quality, provisioning, management, and QoS, across IP, Frame Relay and ATM—from access to the core. Only Ascend can guarantee absolute QoS in a completely integrated solution, offering the industry's most comprehensive solution to enable carriers and ISPs to offer voice services across integrated voice/data networks.



**Where Network
Solutions Never End™**

**Worldwide and North
American Headquarters**
Ascend Communications, Inc.
One Ascend Plaza
1701 Harbor Bay Parkway
Alameda, CA 94502, United States
TEL: 510.769.6001
FAX: 510.747.2300
E-mail: info@ascend.com
Toll Free: 800.621.9578
FAX Server: 415.688.4343
Web Page: <http://www.ascend.com>

European Headquarters
Rudolph-Diesel-Strasse 16
D-64331 Weiterstadt
Germany
Tel: +49.6150.1094.10
Fax: +49.6150.1094.94

Asia-Pacific Headquarters
Suite 1908
Bank of America Tower
12 Harcourt Road
Hong Kong
Tel: +852.2844.7600
Fax: +852.2810.0298

Japan Headquarters
Level 19 Shinjuku Daiichi-Seimei Bldg.
2-7-1 Nishi-Shinjuku
Shinjuku-ku, Tokyo 163-07, Japan
Tel: +81.3.5325.7397
Fax: +81.3.5325.7399
Web Site: <http://www.ascend.co.jp>

**Latin, South America and the
Caribbean Headquarters**
One Ascend Plaza
1701 Harbor Bay Parkway
Alameda, CA 94502, United States
TEL: 510.769.6001
FAX: 510.747.2300