

INTERNET TELEPHONY: COSTS, PRICING, AND POLICY

by

DR. LEE W. MCKNIGHT,

MIT

and

BRETT LEIDA,

MIT

Chapter submitted to the volume of selected papers from the

1997 Telecommunications Policy Research Conference,

David Waterman and Jeffrey MacKie-Mason, Eds.

Introduction

This chapter presents a cost model of Internet service providers and Internet telephony, and assesses its business and policy implications.¹ The term “Internet telephony” has been broadly applied to a family of applications which typically includes (real-time) voice communication, at least partially over a network using Internet protocols. This is in contrast to traditional telephony (or “Plain Old Telephone Service”—POTS) that occurs solely over a circuit-switched telephone network. However, distinctions between Internet telephony and traditional telephony become less clear when one considers telephony services that bridge packet-switched and circuit switched networks. In **Chapter X of this volume**, Clark classifies various types of telephony services that can be realized using these once-disparate networks. The type of Internet telephony analyzed in this model is what Clark calls “Class 3” Internet telephony: computer-to-computer Internet telephony in which two computers communicate over the Internet via a modem connection or a direct network connection.²

It is shown that a moderate use of computer-to-computer Internet telephony can double the costs of an Internet Service Provider. Pricing and policy issues arising from Internet telephony services are also briefly addressed in this chapter. We conclude that both new pricing strategies and supportive policy frameworks are

needed for Internet telephony services to recover costs, and to integrate the Internet and telecommunications industries.

1. Cost Model of Internet Service Providers

A cost model of Internet service providers (ISPs) has been developed by the MIT Internet Telephony Consortium (ITC)³ and the MIT Research Program on Communications Policy (RPCP). The model quantifies the impact on an ISP's costs due to an increased use in Internet telephony. Two scenarios are modeled: a baseline scenario representing current ISPs in which the principal use of the network is for web browsing and there is essentially no Internet telephony; and an Internet telephony (IT) scenario in which the ISP sees a substantial increase in use of computer-to-computer Internet telephony by its subscribers.⁴

The model is used to identify the costs of end-to-end Internet service for various types of users (dial-in, leased-line, etc.). These costs are broken down into five categories:

- *Capital Equipment* - the hardware and software of the network
- *Transport* - the leased-lines of the network and interconnection costs
- *Customer Service* - staff and facilities for supporting the customers
- *Operations* - billing, equipment and facilities maintenance, and operations personnel

- *Other Expenses* - sales, marketing, general and administrative

The next section describes the fundamental assumptions in the model, and the following section describes the elements included in each of the five cost categories.

1.1. Key Model Assumptions

The ISP cost model presented here has over 300 input parameters. Given limited space, each parameter cannot be explained in this document. However, the key assumptions are presented below.⁵

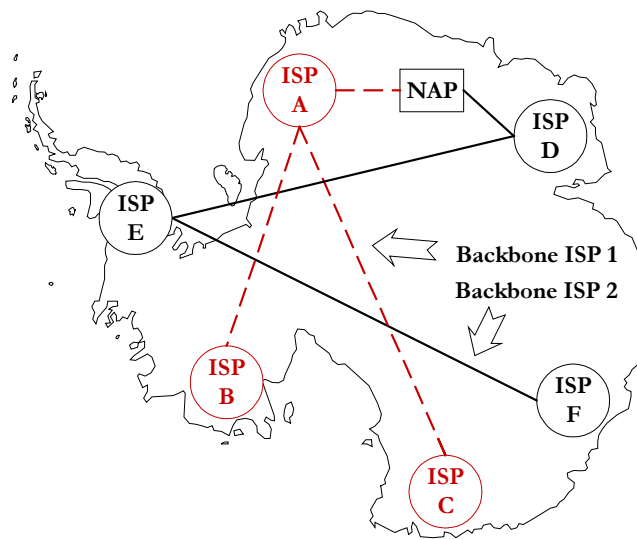

- **Model Represents an Access and Backbone ISP with Leased Transport**

Figure 1. Hypothetical ISP Network Architecture

Internet Service Providers (ISPs) come in all shapes and sizes. Firms with international, facilities-based networks are called ISPs, as are firms with a few modem racks and a leased-line. A model that captures the costs for both types of firms must be carefully designed.

Figure 1 shows a hypothetical market where there are two principal types of ISPs: backbone ISPs (1 and 2 in the figure) and access ISPs (A through F). Each access ISP has a backbone ISP that connects it to other access ISPs. The backbone ISPs interconnect at network access points (NAPs). The ISP-entity represented in the cost model is a single backbone ISP and its associated access ISPs. Hence, the model results do not necessarily correspond to the costs of any particular ISP given the current (U.S.) market structure of separate backbone and access ISPs. However, the model results do represent the total costs of providing end-to-end Internet service, which is the intended goal of the model.

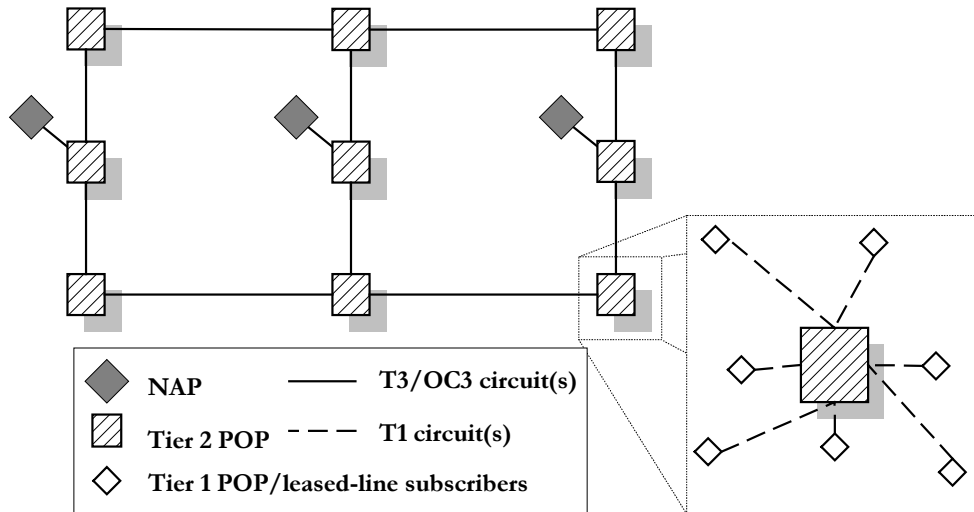

Figure 2. ISP Topology

The network of the modeled ISP is shown in Figure 2. The backbone links are connected at nodes called Tier 2 POPs (point-of-presence), and the access nodes, Tier 1 POPs, are connected in a star network to a Tier 2 POP.⁶

- **Demand is approximated by five subscriber classes**

It is further assumed that identifying costs for the following types of subscribers captures sufficiently the costs of an ISP: residential dial-in subscriber, business dial-in subscriber, ISDN (128 kb dial-in) subscriber, 56 kb (leased-line) subscriber and T1 (leased-line) subscriber.⁷

- **Subscriber prices and levels are from the US market**

Statistics from 1996/97 for the pricing of ISP services and the number of subscribers for the various services in the U.S. were used to determine revenue for the modeled ISP.⁸

- **Bandwidth per dial-in user is 5 kbps for baseline scenario and 3x that for IT**

It is assumed that Internet telephony is used 33% of the time in the IT scenario.

The result is that per-user bandwidth increases by a factor of 1.66 in the IT scenario.⁹ Further, it is assumed that dial-in subscribers will increase their holding time and call arrival rates each by 20% in the IT scenario.¹⁰

1.2. Principal Cost Categories

The ISP's costs are separated into five principal categories: capital equipment, transport, customer service, operations and other expenses (which include sales/marketing and general/administrative).

Each cost element (e.g., router, billing or marketing costs) is determined based on assumptions about how large the costs would be for the given number of subscribers. Once the total cost of an element is known, its cost is allocated to each type of subscriber based on the relative amount of use by each type of subscriber. Carrying out similar calculations for each cost component permits the model to determine the cost per subscriber for each type of subscriber.

1.2.1. Capital Equipment

Capital equipment includes that which is found in the Tier 1 and Tier 2 POPs.

Figure 3 and Figure 4 show how the ISP capital equipment¹¹ is interconnected at a (Tier 1 and Tier 2) POP. Capital investments are converted from a one-time, fixed cost to a leveled, annual cost by using a cost of capital rate.¹²

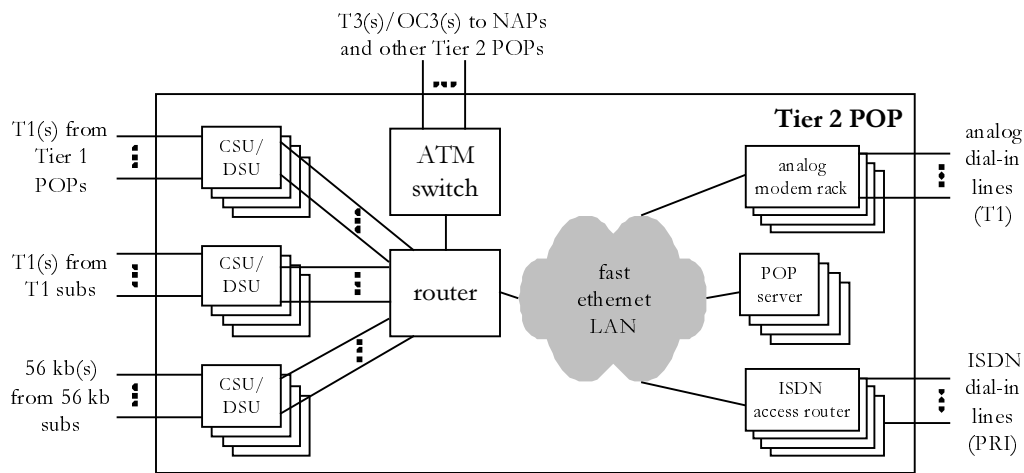

Figure 3. Tier 2 POP

Each piece of capital equipment is sized based on assumptions of users' access patterns and bandwidth requirements. Once the total cost of a piece of equipment is known, its cost is allocated to the various types of subscribers based on the relative amount of use by each type of subscriber. For example, analog modems are sized based on how often the residential and business dial-in subscribers call and how long they stay connected. Once the required number of modems is known (and hence, the cost), the cost is split between the residential and business dial-in subscribers based on how much traffic each type of subscriber generates.

For this particular piece of capital equipment, no modem costs are allocated to the ISDN, 56 kb and T1 subscribers since they do not use this type of equipment.

Similar calculations are carried out for each piece of capital equipment.

1.2.2. Transport

The transport costs of the ISP are comprised of costs due to leased-lines to connect the Tier 1 and Tier 2 POPs (T1s, T3s and OC-3s) and costs due to incoming analog and ISDN phone lines (T1 and PRI) to connect the dial-in subscribers. In addition, monthly costs for the ISP to interconnect at a network access point (NAP) are included in transport costs.

The costs for the leased-lines are based on published tariffs by telecommunications providers such as AT&T, MCI and Sprint. Many telecommunications providers offer substantial discounts for a customer, such as an ISP, who leases circuits in bulk. If the customer commits to a certain number of dollars per month, it will receive a discount according to the range in which its commitment falls. Such bulk discounts are taken into account in the model and are based on published figures by the above-mentioned carriers.

As with the capital equipment costs, transport costs are allocated to the various types of subscribers, e.g., ISDN PRI costs are allocated entirely to the ISDN subscribers, whereas the backbone costs are allocated to each type of subscriber

according to the relative amount of bandwidth required for each type of subscriber.

1.2.3. Customer Service

Customer service is furnished by representatives who provide technical support via the telephone to the subscribers. It is assumed that all dial-in subscribers (analog and ISDN) will be making calls to customer service. Additionally, technical representatives of subscribers with leased-lines, i.e. 56 kb and T1 subscribers, will also call customer service, but it is assumed that these subscribers will have their own internal end-user support, so that the end-users are not calling the ISP's customer service.

For the model, the perspective is taken that customer service is outsourced by the ISP. Hence, instead of determining how large a staff is needed, one determines how many call-minutes there are and what is the cost per minute charged to the ISP.

1.2.4. Operations

Operations correspond to the routine tasks necessary to keep the ISP functioning. Operations costs fall into three principal sections: network operations and maintenance, facilities, and billing.

Network operations and maintenance costs include those for maintaining the hardware and software of the network, as well as the personnel needed to carry out these responsibilities. The costs for the maintenance are based on a percentage of the total costs for the capital equipment, and the personnel costs are based on the number of people needed to maintain the given number of POPs.

Facilities costs are those associated with maintaining a physical space for each POP. Included are such costs as building rent, electricity, heat, etc. The costs are based on an expenditure in \$/month for each type of POP.

The costs of billing for Internet service include those of rendering a monthly bill. There is a fixed fee for generating each bill, and each subscriber receives one bill per month.

1.2.5. Other Expenses

The remaining costs seen by an ISP are included in an Other Expenses category. These costs include sales/marketing and general/administrative. While these costs are not the focus of this study, they are nonetheless part of an ISP's costs and are included to provide a perspective relative to the other cost categories.

CATEGORY	COST	DISTRIBUTION
Capital Equipment	\$3,349,000	11%

Transport	\$7,242,000	24%
Customer Service	\$7,927,000	26%
Operations	\$3,445,000	11%
Sales, Marketing, G & A	\$8,725,000	28%
<i>Total Monthly Cost</i>	\$30,688,000	

Table 1. Baseline Scenario Cost Summary ¹³

Sales and marketing costs are those used to attract and retain subscribers. These costs are based on a percentage of revenue. The value for the percentage is based on figures taken from annual reports of ISPs and other telecommunications service providers.

General and administrative (G&A) expenses consist primarily of salaries and occupancy costs for administrative, executive, legal, accounting and finance personnel. Similar to sales and marketing costs, G&A costs are based on a percentage of total costs. The value for this percentage is also derived from annual reports of ISPs.

2. Cost Model Analysis and Interpretation

This section presents the results of the cost model for the baseline and Internet telephony scenarios. First, results are presented for the baseline scenario, and then results are presented for the Internet telephony scenario. Sensitivity analysis is discussed and the results are summarized.

	magnitude	res.	bus.	ISDN	56 kb	T1
Revenue	\$26.7 M	69.9%	0.3%	1.3%	2.7%	25.8%
Cost	\$30.7 M	69.3%	0.3%	1.0%	2.2%	27.2%

Table 2. Revenue and Cost Comparison ¹⁴

2.1. Baseline Scenario Results

As described previously, the baseline scenario represents an ISP whose users are primarily browsing the web. This scenario is intended to represent an ISP in the 1997 time period.

Table 2 shows the cost results for the baseline scenario. An initial conclusion is that the cost is slightly greater than the revenue. This is not necessarily surprising since many ISPs have had difficulty operating profitably.

The cost and revenue distribution across the subscriber base indicates that no type of subscriber is being substantially subsidized.¹⁵ This indicates that the market for providing Internet access services is relatively efficient and competitive.

Table 3 shows the results across the various cost categories. Capital equipment and operations costs each represent approximately half the costs of the other three categories. In general, however, no particular cost category dominates the ISP's

costs. Taken from another perspective, all cost categories play an important role in determining an ISP's costs.

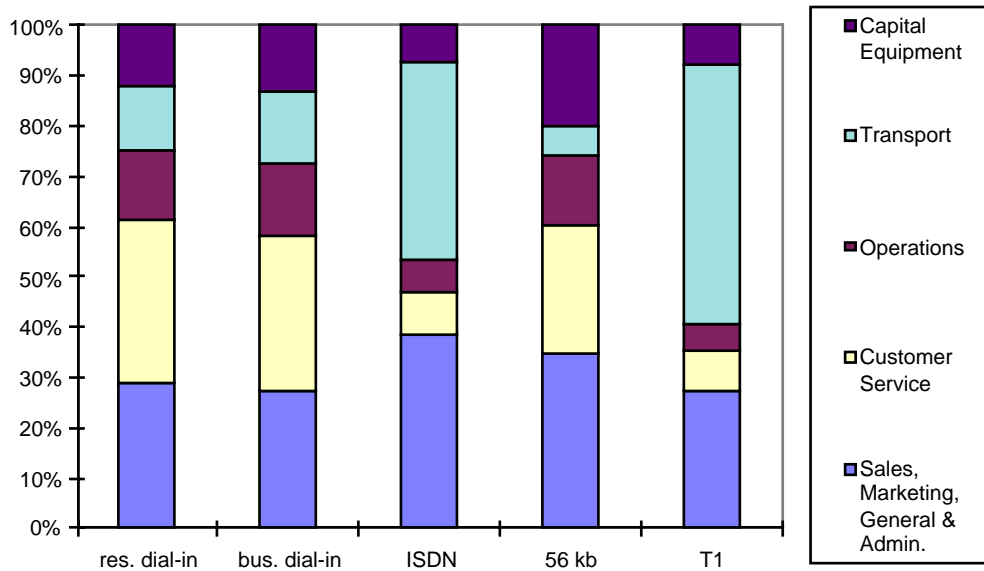

Figure 4. Subscriber Cost Distribution for Baseline Scenario

Figure 4 shows the cost distribution for each type of subscriber. Note that this distribution varies substantially among subscriber type. For example, transport represents only a small portion of cost for dial-in subscribers but a large portion of cost for T1 subscribers. Similarly, customer service is a larger share of dial-in subscribers' cost than T1 subscribers' cost.

The baseline scenario analysis yields the following conclusions:

- 1. No particular cost category dominates the ISP's costs.**¹⁶

2. *There is a substantial variation in cost distribution between the different types of subscribers.*
3. *The ISP's total cost distribution will vary with the subscriber mix and the individual cost distribution* ¹⁷
4. *Non-technical components represent a substantial portion of each subscriber type's costs.*
5. *Internet Service Providers are losing money.*

2.2. Internet Telephony Scenario Results

In this section results are presented for the Internet telephony scenario. First the total ISP costs will be presented and then individual subscriber costs for dial-in and T1 subscribers are presented.

Comparing the Internet telephony scenario to the baseline scenario, costs in all categories increase in the Internet telephony scenario; however, some categories are affected more than others are. The bottom line for an ISP is that *revenues will increase slightly, while costs will increase substantially with only a moderate use of Internet telephony*. Hence, ISPs need to consider how to minimize the cost impact of Internet telephony and/or how to recover additional revenue if they hope to operate at profitable levels. The comparative results for the baseline and Internet telephony scenarios are shown in Figure 5.

Baseline Scenario

Internet Telephony Scenario

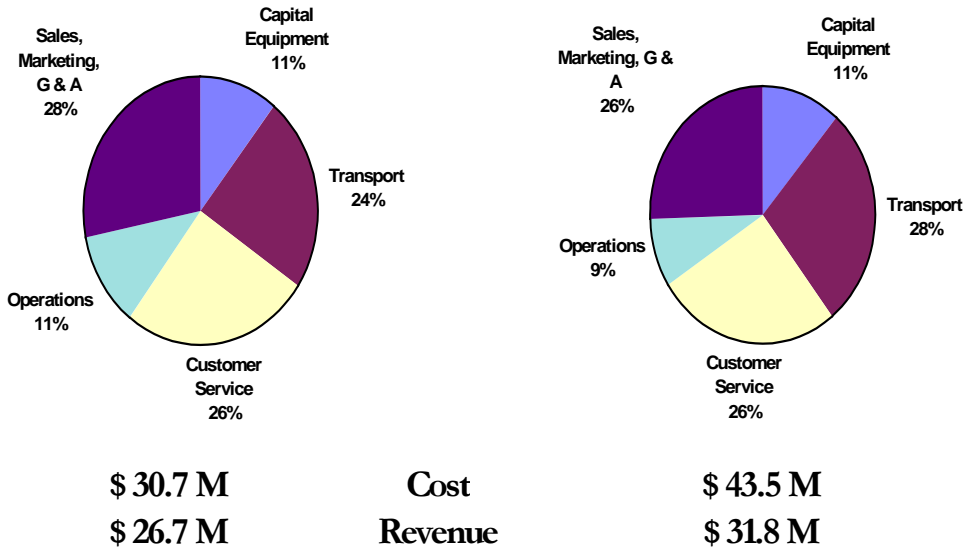

Figure 5. Comparative Cost Results¹⁸

At 28% of total costs, transport costs become the largest cost category in the Internet telephony scenario. The implication for ISPs based on this result is that an ISP that operates its network most efficiently will have a competitive advantage over other ISPs if the Internet telephony scenario takes place. Such efficiencies could come from scale economies, facilities-based networks or network optimization techniques. However, if one believes that the market for transport is already efficient and that transport is essentially a commodity, then there would be fewer opportunities for competitive advantage resulting from owning a network. Even so, network optimization techniques would prove advantageous whether or not the ISP owns or leases its network.

	RES.	BUS.	ISDN	56 KB	T1
Capital Equipment	45%	45%	80%	66%	63%
Transport	75%	75%	85%	64%	64%
Customer Service	44%	44%	44%	43%	44%
Operations	7%	7%	30%	26%	25%
Other Expenses	7%	7%	7%	78%	78%
Total	33%	34%	48%	59%	64%
Cost	\$30	\$32	\$126	\$745	\$2,375

Table 3. Subscriber Cost Increase ¹⁹

Subscriber costs are impacted in different ways. Table 3 shows the percentage increase in each cost category for each subscriber type. For example, transport costs increased by 75% for the analog dial-in subscribers. In general, transport costs are substantially impacted for each subscriber type. Costs in the other expenses category increase for the leased line subscribers (56kb and T1) due to an increase in sales and marketing costs. This is based on the assumption that leased-line subscribers would purchase enough capacity to maintain their circuit at the same level for both scenarios. Hence, additional revenue is received from the leased-line subscribers in the Internet telephony scenario. Because sales and marketing costs are based on a percentage of revenue, these costs also increase.

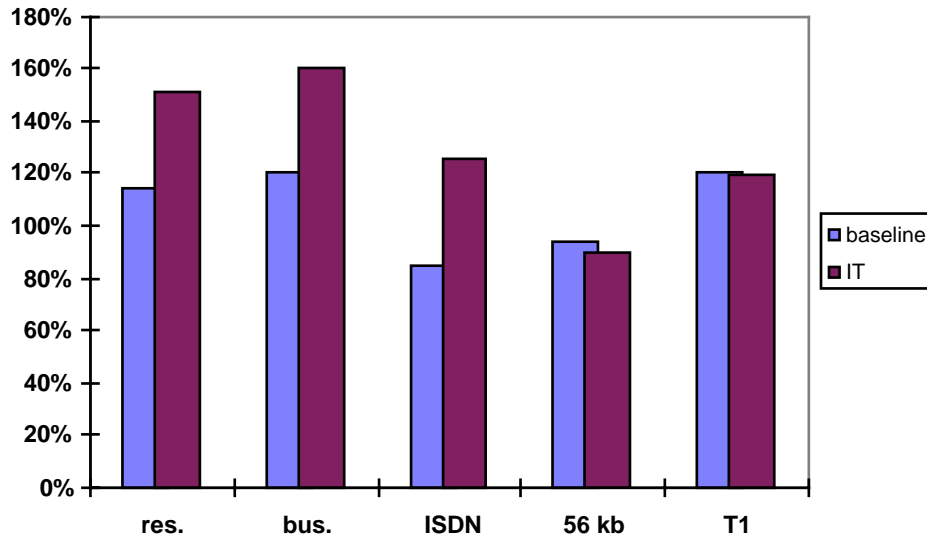

Figure 6. Cost/Revenue Ratio for Baseline and IT Scenarios ²⁰

Drawing conclusions based on comparing the change in costs between the different types of subscribers is not valid because the revenue is also changing, but only for the leased-line subscribers. One method of comparing the impact on the different types of subscribers is to consider a cost/revenue ratio for both scenarios, which is presented in Figure 6. Here one can see that the dial-in subscribers become particularly unprofitable, but the leased-line subscribers remain at about the same level of profitability as in the baseline scenario.

Table 4 shows a breakdown of the ten highest-cost elements for residential dial-in subscribers. In the IT scenario, the cost elements for the dial-in subscribers maintain a similar distribution as for the baseline scenario. Two transport cost

elements (analog dial-in T1 and T1 transport) increased, but only moderately.

Non-technical costs, such as customer service, sales/marketing and general/administrative, together represent 59% of the per-user costs. Hence, as in the baseline scenario, non-technical costs still play an important factor even in the face of Internet telephony.

ITEM	COST	% (IT)	% (BASELINE)
customer service	\$10.80	36%	33%
sales and marketing	\$4.00	13%	18%
analog modems	\$3.51	12%	11%
general and administrative	\$3.01	10%	11%
analog dial-in T1	\$2.68	9%	8%
T1 transport	\$2.07	7%	4%
billing	\$1.25	4%	5%
POP personnel	\$0.92	3%	4%
s/w and h/w maintenance	\$0.78	3%	2%
T3/OC-3 transport	\$0.42	1%	4%
<i>Total of top ten items</i>	<i>\$29.43</i>	<i>97%</i>	

Table 4. High Cost Components for Res. Dial-in Subs. (IT Scenario) ²¹

ITEM	COST	% (IT)	% (BASELINE)
------	------	--------	--------------

T3/OC-3 transport	\$1,103	46%	46%
sales and marketing	\$398	17%	17%
general and administrative	\$300	13%	10%
customer service	\$173	7%	8%
NAP Interconnection cost	\$116	5%	5%
Cisco 7513 serial port card	\$78	3%	3%
T1 CSU/DSU	\$61	3%	3%
POP personnel	\$44	2%	3%
s/w and h/w maintenance	\$37	2%	2%
Cisco 7513 router chassis	\$33	1%	1%
<i>Total of top ten items</i>	<i>\$2,343</i>	<i>99%</i>	

Table 5. High Cost Components for T1 Subs. (IT Scenario) ²²

As in the baseline scenario, (backbone) transport costs are still the major cost element for the T1 subscribers in the Internet telephony scenario (Table 5).

Hence, those ISPs targeting T1 subscribers can gain substantial cost savings by having the most efficient network. This is in contrast to ISPs who target analog dial-in subscribers, for example, who would only receive marginal benefit by optimizing their network. For them, substantial cost savings can also be gained by targeting customer service and sales and marketing areas.

Sensitivity analysis of key parameters can provide further insight into the impact of Internet telephony on users' costs. For dial-in subscribers, modem costs are

principally impacted by usage patterns. In the Internet telephony scenario, it was assumed that call arrival rates and holding times each increased by 20% vis-a-vis the baseline scenario. Additionally, it was assumed that Internet telephony is used 33% of the time that a user is online. These two parameters could be varied independently according to various scenarios. Figure 7 shows how a dial-in user's total cost would change under these types of scenarios.²³ The end-result is that a dial-in user can impact his costs more by increasing total time online than by spending the same amount of time online while solely using Internet telephony. Similar analysis for customer service costs of dial-in subscribers shows that a doubling of customer service requests over the baseline scenario increases total subscriber costs by approximately 35%. Hence, any activity that prompts a user to spend more time online and to make more customer service requests will have a substantial impact on an ISP's costs. For T1 subscribers total costs are sensitive to changes in the usage patterns, which would seem intuitively correct because transport costs represent a large portion of T1 subscribers' costs.²⁴

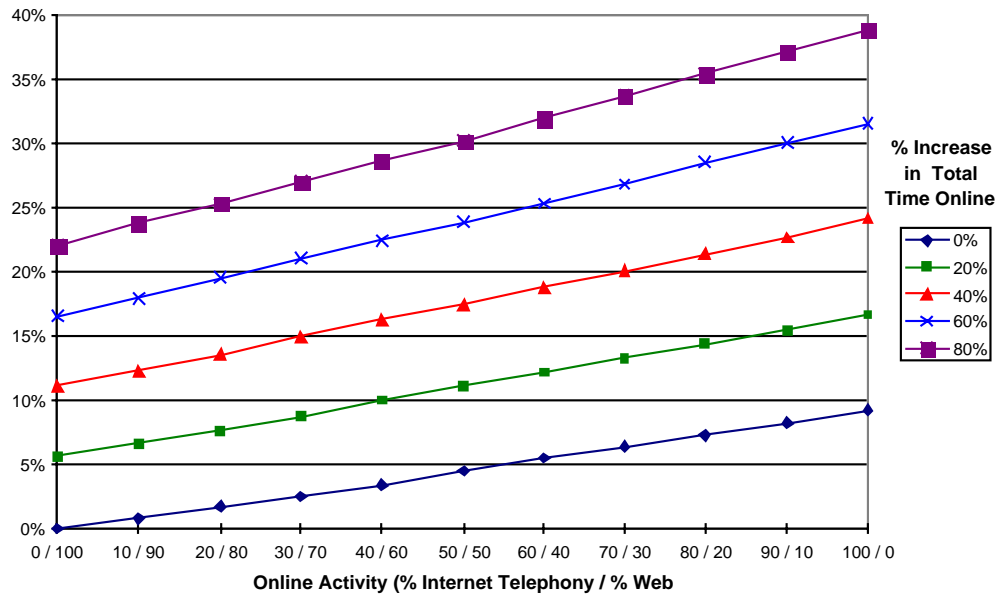

Figure 7. Internet Telephony and Usage Level Impact on

Dial-in Subscriber's Costs

The Internet telephony scenario analysis yields the following conclusions:

- 1. In the IT scenario, the increase in the ISP's costs is double the revenue increase. Hence, ISPs will lose even more money if they do not attempt to recover additional costs.*
- 2. Transport costs become the largest cost category in the IT scenario.*
- 3. Non-technical costs still remain a large portion of per-user costs, especially for dial-in subscribers.*

- 4. Dial-in subscribers' costs are sensitive to access patterns and customer service costs. T1 subscribers' costs are sensitive to bandwidth usage patterns.*

3. Internet Telephony Pricing

As described previously, ISPs face potential increased cost pressure due to Internet telephony. To a lesser extent, they also face cost pressure due to access charge reform, which is discussed in the next section. For ISPs to remain in business, they will need to recover these increased costs. The Resource ReSerVation Protocol (RSVP) developed by the Internet Engineering Task Force (IETF) could be used as a mechanism for implementation of usage-sensitive pricing to recover those costs.²⁵ However, whether and where the current specification of RSVP is useful has not yet been determined. It is clear that RSVP by itself is not capable of resolving the host of network architecture and Quality of Service constraints on Internet pricing models. For example, how RSVP traffic could cross multiple networks has not been resolved.

When developing pricing schemes, service providers will have to look beyond the Internet telephony service and consider how to price differentiated and/or integrated Internet services generally. We argue elsewhere that an integrated regulatory framework will be required to permit the provision of such integrated services (Neuman, McKnight, and Solomon, 1997).

Alternatives for pricing include flat-rate, or the introduction of usage-sensitive pricing. In McKnight and Bailey (1997), a variety of proposed approaches to Internet pricing, including approaches at the infrastructure level for network interconnection, are presented (see Bailey and McKnight, 1997). In the next few years, we anticipate experimentation with a variety of pricing models that permit service guarantees for multiple qualities of service, including guarantees for both real-time multimedia and multicast conferencing.²⁶

Employment of yield management techniques, which may enable use of innovative service definitions in the face of highly variable demand to maximize revenue should also be considered.²⁷ Yield management, which originated in the airline industry and is discussed further in (Leida, 1998), uses a combination of service definition, pricing and admission control. The fundamental principle of yield management is that different classes of service, be it Internet access or Internet telephony, are defined and only the high priority classes are served during peak periods of demand. During low periods of demand, discount classes are intended to attract an increased level of demand. The consequence of such techniques is that the system's capacity is more full on average and revenues are higher.

Additionally, one must consider the state of technology when considering cost-recovery alternatives. Usage-sensitive pricing will not be an option until protocols that monitor the use of Internet telephony are deployed widely.

4. Internet Telephony Policy

There are a variety of policy issues raised by Internet telephony, none of which were addressed by the Telecommunications Act of 1996, which is a recipe for gridlock of a decade of litigation around the issues of the redefinition of market structures (Neuman, et al., 1997). There appears to be a self-correcting quality to the degree to which policy frameworks can become misaligned with technical and economic conditions, but the time lag and social welfare loss may be substantial. Here, we focus particularly on a quantitative estimate of the costs for Internet telephony service providers. Additionally, we touch briefly upon the regulatory discussions surrounding Internet telephony within the European Union.

The regulatory treatment of the Internet and Internet telephony service providers, in particular, has attracted substantial attention but little insight as yet. Broader discussion of a model for a new, convergent regulatory framework, with no distinctions between wireline and wireless, narrowband and broadband, broadcast and switched service, and content and conduit, may be found in Neuman, et al. (1997).

4.1. Access Charge Reform

Telephony has been traditionally one of the most regulated industry segments in the United States. Under FCC rules (specifically, the Computer II Inquiry) ISPs, being classified as “enhanced service providers,” are exempt from regulations imposed on “carriers,” such as long-distance telephone companies.²⁸ These carriers must pay per-minute “access charges” on the order of \$0.06 per minute to the local phone companies who terminate each end of a long distance call [WE97]. A trade association of telephone companies-America’s Carriers Telecommunications Association (ACTA)-filed a petition with the FCC asking it to regulate Internet telephony [AC96]. ACTA argued that ISPs providing Internet telephony services should pay access charges to the local telephone companies-as do other long-distance service providers.

In May 1997 the FCC unveiled a reformed access-charge system.²⁹ While not ruling explicitly on the ACTA petition, the FCC chose to not require ISPs to pay per-minute access charges.³⁰ Instead, the FCC imposed increased phone charges on business users-ISPs included-and residential users with a second phone line in the form of an increased Subscriber Line Charge (SLC) and a new Presubscribed Interexchange Carrier Charge (PICC).

Under the new rules ISPs will see an increase in cost of their analog dial-in lines. The SLC goes from a cap of \$5.60 per-line per-month to \$9.00 on Jan. 1, 1998

(although few LECs will be able to charge as high as the cap; the average has been calculated to be \$7.61), and the PICC goes from \$0.53 to \$2.75 per-line per-month. Using the average charges, the impact on ISPs (or any multi-line business) will be a \$4.23 per month increase for each analog line.³¹ Plugging these updated costs into the ISP cost model yields an increase for the analog dial-in subscribers' cost for both the baseline and IT scenarios. Table 6 shows the initial results for the two scenarios compared to the results for the two scenarios with the access reform.

	BASELINE	BASELINE W/ ACCESS REFORM	IT	IT W/ ACCESS REFORM
Capital Equipment	\$2.70	\$2.70	\$3.90	\$3.90
Transport	\$2.98	\$3.44	\$5.21	\$5.86
Customer Service	\$7.50	\$7.50	\$10.80	\$10.80
Operations	\$3.07	\$3.07	\$3.27	\$3.27
Other Expenses	\$6.52	\$6.57	\$7.01	\$7.06
<i>Total</i>	\$22.77	\$23.27	\$30.19	\$30.89

Table 6. Analog Dial-in Subscriber Costs for 4 Scenarios ³²

An alternative method of access reform could have been to implement per-minute access charges for ISPs-as proposed in the ACTA petition. The effect of such reform is shown in Figure 8. This analysis is based on the residential dial-in

subscriber of the baseline scenario who spends 1233 minutes per month online (approximately 41 minutes per day). The dial-in subscriber monthly cost is displayed as the per-minute access charge is varied. The result is that access charges quickly become the dominating cost element for a dial-in subscriber. ISPs would surely have to pass this cost increase on to the end-user, which would have the effect of greatly impeding the continued growth in dial-in Internet services.

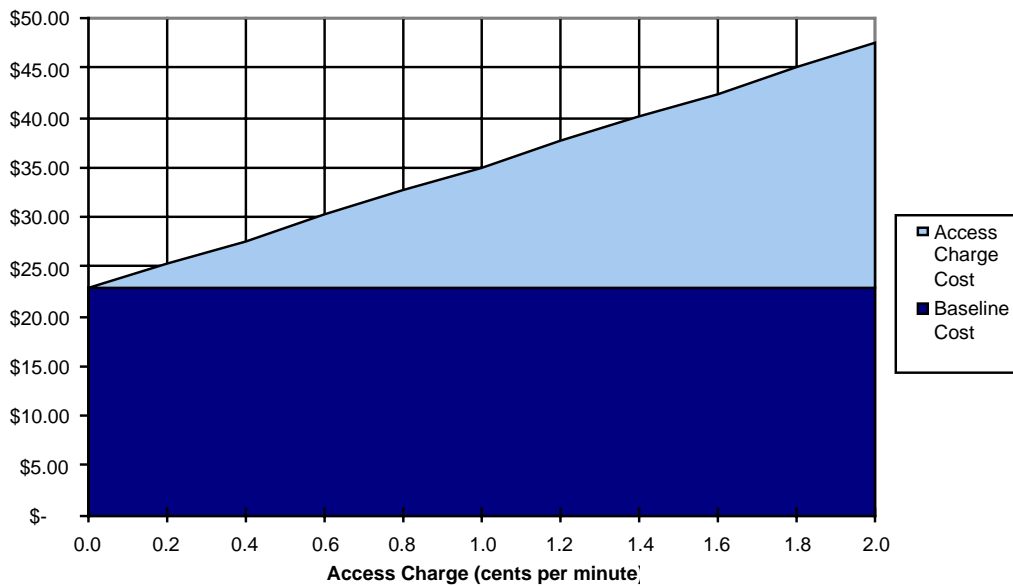

Figure 8. Access Charge Impact on Dial-in User Cost ³³

While no cost increase is advantageous to ISPs, the recent FCC actions should be considered much less threatening than the potential impact of Internet telephony or of per-minute access charges. A principal conclusion that one reaches based on

these cost results is that ISPs need either to prevent widespread use of Internet telephony, or to change the current pricing structure of Internet access services in order to recover the increased costs.

4.2. European Internet Telephony Policymaking

As we have noted above, perhaps the greatest challenge for Internet telephony is how it will be treated by governments. The Internet is indeed growing in importance in the United States, and has therefore been focused on at the highest levels of the U.S. government more than in most other nations. But it would be a mistake to ignore regulatory dilemmas and proposed approaches arising elsewhere. In particular, the European Commission's approach to determining policy for Internet telephony merits attention, because of the obvious impact such policies may have in enabling, or inhibiting, the continued growth of a worldwide market for advanced Internet services.

Heterogeneity has been a key characteristic of the Internet from its beginning. The question of how much heterogeneity in Internet policy is tolerable for various classes of service will soon be answered in practice by policymakers and Internet users.

As discussed in [SH97], the European Commission has established several criteria that Internet telephony must meet before it will be subject to regulation. These

criteria, initially published in (European Commission Directorate [EC], 1997), are presented in Table 7.

Such communications are subject of a commercial offer.
Such communications are provided for the public.
Such communications are to and from the public switched network termination points on a fixed telephony network.
Such communications involve direct transport and switching of speech in real-time.

Table 7: EU Criteria for Voice Telephony ³⁴

Based on these criteria, Internet telephony is not considered voice telephony because Internet telephony does not meet the criterion of “real-time” communication due to the current, high levels of delay experienced by Internet telephony users on the public Internet.³⁵ Hence, Internet telephony services in Europe are not subject to regulation at this time.

5. Conclusions

Internet telephony service providers confront a variety of challenges. The costs, the technologies, business and pricing models, as well as the policy environment for Internet telephony are all unsettled and in a state of rapid evolution.

So far, a relatively hands-off policy approach has been taken by the Federal Communications Commission (FCC) in the U.S. A similar policy position has also been taken by the European Union. In spite of misguided efforts in some countries to ban Internet telephony, we believe the real challenge is how to align the costs, technologies, prices, and policies to enable a rich new class of differentiated and integrated Internet services to flourish, subsequently bringing substantial benefits to consumers. Internet telephony is acting as a catalyst, restructuring the telecommunication industry. The rapid growth of new IP-based infrastructures, services, and applications resulting from these trends should benefit both consumers and producers worldwide, while hastening the “creative destruction” of outmoded regulatory regimes, industry structures, and business practices.

In this chapter, we have described a cost model, developed by the Internet Telephony Consortium (ITC), of Internet telephony service providers. The model puts the ISP's costs into five categories: capital equipment, transport, customer service, operations and other expenses (sales/marketing and general/administrative).

The model was evaluated with two scenarios: The baseline scenario, which represents an ISP today where its subscribers use primarily the Web; and the

Internet telephony scenario where the ISP sees a significant rise in the use of computer-to-computer Internet telephony. This scenario is in contrast to another potential Internet telephony scenario where a telephone service provider desires to replicate the PSTN using Internet telephony technology.

It was shown that with a moderate use of Internet telephony the increase in total ISP costs is nearly double the increase in revenues. Hence, ISPs, many of which are currently operating at unprofitable levels, would lose even more money if they fail to adopt new business models and change pricing policies to recover additional costs. Alternatives for cost recovery include various pricing and yield management techniques, some of which we have explored elsewhere (McKnight, and Bailey, 1997; Leida, 1997).

The cost model presented and analyzed here provides a snapshot in time; conclusions (and the models on which conclusions may be drawn) must be reassessed, in real time, as technologies, industries, and regulatory environments evolve.

References

- Bailey, J.P. & McKnight, L.W. (1997). Scalable Internet Interconnection Agreements and Integrated Services. In B. Kahin & J.H. Keller (Eds.), Coordinating the Internet (p. 309). Cambridge, MA: MIT Press.
- Boardwatch Magazine Directory of Internet Service Providers. (Winter 1997).
- European Commission Directorate-General for Competition (DGIV). (July 5, 1997). *Notice by the Commission concerning the status of voice on the Internet under Directive 90/388/EEC*, OJ C 140_(p. 8).
<http://www.europa.eu.int/en/comm/dg04/lawliber/en/97c140.htm>.
- Federal Communications Commission. (rel. Dec. 24, 1996). *Access Charge Reform, Price Cap Performance Review for Local Exchange Carriers, Transport Rate Structure and Pricing and Usage of the Public Switched Network by Information Service and Internet Access Providers*, CC Docket Nos. 96-262, 94-1, 91-213, and 96-263, *Notice of Proposed Rulemaking, Third Report and Other and Notice of Inquiry*, FCC 96-488 (Access Reform NPRM).

Federal Communications Commission. (rel. May 8, 1997a). *Federal-State Board on Universal Service*, CC Docket No. 96-45, First Report and Order, FCC 97-157 (Universal Service Order).

Federal Communications Commission. (rel. May 16, 1997b). *Price Cap Performance Review for Local Exchange Carriers and Access Charge Reform*, CC Docket Nos. 94-1 and 96-262, Fourth Report and Order in CC Docket No. 94-1 and Second Report and Order in CC Docket No. 96-262, FCC 97-159 (Access Reform Second Report and Order).

Federal Communications Commission. (May 7, 1997c). *Commission Reforms Interstate Access Charge System*, Report No. CC 97-23.

FIND/SVP. (October 1996). Home Use of the Internet and Commercial Online Services. <http://etrq.findsvp.com/financial/homeuse.html>.

Forrester Research, Inc. Telecom Strategies Group. (August 1996). Sizing Internet Services.

Leida, B. (1998). A Cost Model of Internet Service Providers: Implications For Internet Telephony And Yield Management. MIT S.M. Thesis.

McKnight, L.W. & Bailey, J.P. (Eds.). (1997). Internet Economics. Cambridge, MA: MIT Press.

Morgan Stanley (Technology/New Media). (February 1996). The Internet Report.

<http://www.ms.com>.

Neuman, W.R., McKnight, L., and Solomon, R.J. (1997). The Gordian Knot:

Political Gridlock on the Information Highway. Cambridge, MA: MIT Press.

Paschalidis, I., Kavassalis, P. and Tsitsiklis, J.N. (1997). Efficient Resource

Allocation and Yield Management in Internet Services. In Internet Telephony Consortium Year-End Report.

Short, K.I. (1997). Towards Integrated Intranet Services: Modeling the Costs of

Corporate IP Telephony. MIT S.M. Thesis.

Students of the MIT Telecommunications Modeling and Policy Analysis Seminar.

(1996). *A Cost Model of Internet Telephony for Regulatory Decision Making, In the Matter of "The Provision of Interstate and International Interexchange Telecommunications Service via the 'Internet' by Non-Tariffed, Uncertified Entities."* TPP91, MIT.

<http://itel.mit.edu/docs/ACTA/TPP91.htm>.

Werbach, K. (1997). *Digital Tornado: The Internet and Telecommunications Policy*, Federal Communications Commission Office of Plans and Policy, OPP Working Paper No. 29.

Authors' Contact Information

Dr. Lee W. McKnight

(mcknight@rpcp.mit.edu)

Lee is the Principal Investigator of the MIT Internet Telephony Consortium (<http://itel.mit.edu>), Principal Research Associate at the Center for Technology, Policy, and Industrial Development, Massachusetts Institute of Technology, and is a Lecturer for the Technology and Policy Program at MIT.

Lee is co-author of The Gordian Knot: Political Gridlock on the Information Highway (MIT Press, 1997; <http://www-mitpress.mit.edu/book-home.tcl?isbn=0262140616>) and is co-editor of Internet Economics (MIT Press, 1997; <http://www-mitpress.mit.edu/book-home.tcl?isbn=0262133369>).

Brett A. Leida

(brett@mit.edu)

Brett is a graduate student at MIT. He completed his Master's thesis for the Technology and Policy Program and Electrical Engineering and Computer Science, and has begun a Ph.D. program in Operations Research at MIT. He is currently a research assistant with the MIT Internet Telephony Consortium.

¹ Support for this research from the MIT Internet Telephony Consortium (<http://itel.mit.edu>) is gratefully acknowledged. This paper is based upon Brett Leida's S.M. thesis entitled, "A Cost Model of Internet Service Providers: Implications for Internet Telephony and Yield Management." The authors would like to thank ITC staff members and companies for providing valuable feedback via five conference calls in March-April 1997, ITC meetings in May 1996, and January and June 1997. They would also like to credit NMIS for partial support, NSF Grant NCR-9307548; and the students of the MIT Telecommunications Modeling and Policy Analysis Seminar (TPP91) for an initial model which was presented to the FCC in May 1996 (Students, 1996). This paper extends slightly the model in (Leida, 1998) to explore the impact of FCC policy decisions on costs.

² Ongoing work within the MIT Internet Telephony Consortium models Internet telephony across gateways, both within corporate intranets and over extranets. Results of this work, however, are not yet available, as of the date of this writing.

³ More information about the ITC can be found at <http://itel.mit.edu/>.

⁴ As noted in endnote 2, the issue of gateway traffic, i.e. phone-gateway-phone, is not modeled here. Other work in the ITC is analyzing gateway issues.

⁵ For a more detailed description of each model parameter see (Leida, 1998).

⁶ Further discussion about ISP architecture is found in (Leida, 1998).

⁷ The sole distinction between residential and business dial-in subscribers is varying access patterns. Residential subscribers are assumed to request access primarily in the evening and business subscribers during the day. See (Leida, 1998) for more details on access patterns.

⁸ Sources include: FIND/SVP, 1996; Forrester Research, 1996; Morgan Stanley, 1996; and Boardwatch, 1997.

⁹ $1.66 = 300\% * 33\% + 100\% * 67\%$.

¹⁰ Because the leased-line subscribers' users are "always on" the network, the concept of dialing-in does not apply to them.

¹¹ ISP capital equipment considered in the model are: analog modems, content housing server, 56 kb CSU/DSU, Cisco 7513 serial port card, Fore 4 port DS3 card; ISDN access router, LAN-10Mbps ethernet, T1 CSU/DSU, Cisco 7513 ATM card, Fore 4 port OC-3 card; POP server, LAN-100Mbps ethernet, Cisco 2500 router, Cisco 7513 router chassis, and a Fore ASX-200BX ATM switch chassis.

¹² See (Leida, 1998) for details.

¹³ (Leida, 1998).

¹⁴ (Leida, 1998).

¹⁵ This is in contrast to the PSTN, for example, where, based on government desires, the business subscribers subsidize the residential subscribers.

¹⁶ However, this is only true for the mix of subscribers used in the baseline scenario. Other mixes of subscribers would yield different results.

¹⁷ Hence, if the subscriber mix changed, the ISP's cost distribution would be weighted by the number of each type of subscriber. For example, if the ISP had only T1 subscribers, its cost would be distributed just as the T1 subscribers' cost is distributed.

¹⁸ (Leida, 1998).

¹⁹ (Leida, 1998).

²⁰ (Leida, 1998).

²¹ (Leida, 1998).

²² (Leida, 1998).

²³ The cost increase is relative to that of the baseline scenario. Because all other costs are held constant (such as customer service, sales and marketing) the cost increase shown in this figure will not be the same as the for the Internet telephony scenario where other costs were assumed to increase.

²⁴ See (Leida, 1998) for further sensitivity analysis.

²⁵ IETF rfc2205 (<http://reference.nrcs.usda.gov/ietf/rfc2300/rfc2205.txt>)

²⁶ The announcement by America Online (AOL), in January 1998, that it was raising the price for its service to \$21.95/month from \$19.95/month suggests that at least one major ISP recognizes that the revenue/cost equation must be brought into balance, as we argue here.

²⁷ For example, see (Paschalidis, Kavassalis, and Tsitsiklis, 1997). Ideally, a company using yield management wants to maximize its profit, not just its revenue. However, in most cases where yield management is currently used, the marginal cost of providing service is very small vis-a-vis fixed costs. Hence, maximizing revenue is essentially the same as maximizing profit.

²⁸ In its "Computer II Inquiry" [FCC80], the FCC established the definition of (basic and) enhanced service providers and chose not to regulate them for reasons of public interest. Based on this definition, ISPs have always been classified as enhanced service providers (Werbach, 1997), p.32].

²⁹ See (FCC, 1997b).

³⁰ More generally, the FCC is trying to move away from the per-minute charges that were developed in the 1980's when telephone service was generally a monopoly to a system of flat-rate charges that will be more compatible with a competitive market.

³¹ $(\$7.61 - \$5.60) + (\$2.75 - \$0.53) = \$4.23$.

³² (Leida, 1998).

³³ (Leida, 1998).

³⁴ (Short, 1997).

³⁵ (Short, 1997).