

**Internet Telephony Gateway
VIP-000/200/400
User's Manual**

Rev 4.0

FCC Notice

This equipment has been tested and found to comply with the limits for a Class A digital device, pursuant to Part 15 of FCC Rules. These limits are designed to provide reasonable protection against harmful interference when the equipment is operated in a commercial environment. This equipment generates, uses, and can radiate radio frequency energy and, if not installed in accordance with the instruction manual, may cause harmful interference to radio communication. Operation of this equipment in a residential area is likely to cause harmful interference in which case the user will be required to correct the interference at the user's own expense.

Disclaimer

PLANET Technology does not warrant that the hardware will work properly in all environments and applications, and makes no warranty and representation, either implied or expressed, with respect to the quality, performance, merchantability, or fitness for a particular purpose. PLANET has made every effort to ensure that this User's Manual is accurate; PLANET disclaims liability for any inaccuracies or omissions that may have occurred. Information in this User's Manual is subject to change without notice and does not represent a commitment on the part of PLANET. PLANET assumes no responsibility for any inaccuracies that may be contained in this User's Manual. PLANET makes no commitment to update or keep current the information in this User's Manual, and reserves the right to make improvements to this User's Manual and/or to the products described in this User's Manual, at any time without notice. If you find information in this manual that is incorrect, misleading, or incomplete, we would appreciate your comments and suggestions.

CE Declaration of conformity

This equipment complies with the requirements relating to electromagnetic compatibility, EN 55022 class A for ITE and EN 50082-1. This meets the essential protection requirements of the European Council Directive 89/336/EEC on the approximation of the laws of the Member States relating to electromagnetic compatibility.

Trademarks

All brand, company and product names are trademarks or registered trademarks of their respective companies.

Revision

PLAENT VIP-000/200/400 User's Guide

Revision: 4.0

August 2002

Part No. EM-VIPV4

How to Use This Manual

This manual was designed for the technical and non-technical users of PLANET Internet telephony gateway VIP-000/200/400. It contains information about the functions of VIP and instructions for its installation, basic configuration and operation in related chapters, and introduces more advanced command line interface, firmware upgrade and appendix information. Read this section carefully for important information about the manual's organization.

Chapter 1: Overview

This chapter provides conceptual overview and description of VIP, explanation of how VIP interacts with each for enabling VoIP services, and an overview of the required tasks

Chapter 2: Installing VIP

This chapter describes required steps to properly and safely install and configure VIP on your network

Chapter 3: VIP Concepts

This chapter gives information about VIP technology and describes basic concepts using VIP for providing telephony services over IP network

Chapter 4: Configuring VIP from Web Browser

This chapter explains procedures for configuring VIP from a web browser

Chapter 5: Making a Call with VIP

This chapter explains how to make Internet calls from telephony devices connected to VIP directly or indirectly.

Chapter 6: Troubleshooting Tips

This chapter provides troubleshooting information in case the user has problems installing or maintaining VIP.

Chapter 7: Command Line Interface

This chapter describes how to access the command line interface. It also contains information about the commands used to configure VIP.

Chapter 8: Upgrading VIP

This chapter explains how to download new revision software and upgrade VIP.

Appendix A: Technical Specifications

This appendix lists VIP specifications and the assignment of pins of all the interface ports.

Appendix B: CLI Commands

This appendix provides a short description of each CLI command with a reference to the pages that contain detailed information on the command.

Appendix C: Factory Default Settings

This appendix lists factory settings of VIP.

Appendix D: Worksheets

This appendix provides some work sheets that you may use before configuring VIP.

Important Safety Instructions

Before plugging VIP into an electrical outlet, carefully read all the installation instructions in Chapter 2.

For your own safety and the safety of your equipment, always take the following precautions:

- Follow instructions and warnings in the documentation.
- Never push any object through the fan vent or other openings in the equipment. Such action may produce a short circuit, causing fire, electric shock, or equipment damage.
- Keep VIP away from all chemicals and sources of liquids.

Warning

- Connection of the RJ45 connector from a VIP to TNV circuits can cause permanent damage to VIP.
- Incorrectly connecting telephony devices to the RJ11 port on the Telephony Interface Module can cause permanent damage to the module.

Documentation Abbreviations

Throughout this guide, the user will come across a number of abbreviations that are common throughout the industry. The user should be familiar with the following abbreviations:

ATPM	Address Translation and Parsing Manager
CLI	Command Line Interface
DSP	Digital Signal Processor
DTMF	Dual Tone Multi-Frequency
E&M	Ear & Mouth
FXO	Foreign Exchange Office
FXS	Foreign Exchange Subscriber
H.323	ITU specification for multimedia transmission over IP networks
ICMP	Internet Control Message Protocol
IMTC	International Multimedia Telecommunications Consortium
IP	Internet Protocol
ITG	Internet Telephony Gateway
KTS	Key Telephone System
LAN	Local Area Network
NVS	Non-Volatile Storage
LED	Light Emitting Diode
PBX	Private Branch Exchange
PSTN	Public Switched Telephone Network
RTP	Real-Time Transport
TCID	Telephony Channel Identifier
TFTP	Trivial File Transfer Protocol
TIM	Telephony Interface Modules
TNV	Telephone Network Voltage
UDP	User Datagram Protocol
UTP	Unshielded Twisted Pair
VAD	Voice Activity Detection
WAN	Wide Area Network

Notation Conventions

Throughout this guide, different type styles and characters are used. These serve a variety of purposes as described below:

Convention	Description
boldface	Commands and keywords are in boldface .
<i>italic</i>	Arguments for which you supply values are in italics.
courier	Messages that VIP CLI displays are in plain courier font.
[]	Elements in square brackets are optional.
{ x y z }	Alternative but required elements are grouped in braces ({ }) and separated by vertical bars ().
[x y z]	Optional alternative keywords are grouped in brackets ([]) and separated by vertical bars ().
string	A nonquoted set of characters. Do not use quotation marks around the string or the string will include the quotation marks.

Table of Contents

Chapter 1 Overview	1
1.1 Features	1
1.2 Networking Protocols	1
1.3 Package Contents	2
1.4 Front Panel	2
LED Indicators	2
Ports	3
Reset Button	3
1.5 Rear Panel	3
Chapter 2 Installing VIP	5
2.1 Network Requirements	5
2.2 Installing VIP	5
2.3 Installing the telephony interface module	5
2.4 Connecting to the telephony devices	5
2.5 Connecting to the Network	6
2.6 Providing Power to VIP	6
2.7 Assigning IP address to VIP	6
Chapter 3 VIP Concepts	7
3.1 How VIP Operates	7
3.2 ATPM	7
3.3 Destination	7
3.4 Hunt Group	8
3.5 Dial Plan	8
Address Table	8
Hunt Group Table	9
Destination Table	9
3.6 DTMF Relay	9
3.7 Voice Codecs	9
Chapter 4 Configuring VIP from a Web Browser	11
4.1 Http setting mode	11
4.1.1 Dial Plan/ Dial Settings	13
4.1.1.1 Phone number	14

4.1.1.2 Hunt Group	16
4.1.2 Clear DialPlan	19
4.1.3 Restore DialPlan	19
4.1.4 Save to NVRAM	20
4.2 View System Configurations	20
4.2.1 Firmware Version Information	21
4.2.2 H323 Parameters	21
4.2.3 Voice Coder Type	22
4.2.4 Voice Coder Information	22
4.2.5 Channel Parameters	23
4.2.6 Network Connection	24
4.2.6.1 DHCP Settings	24
4.2.6.2 PPPoE Settings	25
4.2.6.3 DDNS Settings	26
4.3 Configure System Settings	27
4.3.1 IP Settings	28
4.3.2 H323 Parameters	28
4.3.2.1 H323 General Parameter Settings	28
4.3.2.2 H323 Gatekeeper Settings	30
4.3.2.2 H323 Aliases Settings	31
Chapter 5 Making a Call with VIP	33
5.1 Making a call with VIP FXS Module	33
5.2 Making a call with VIP FXO Module	33
5.3 Making a call with VIP Application Sample	34
Making a call between gateway A and Gateway B	36
Case 2: Gateway Phone to PSTN Phone,	36
Case 3: PSTN Phone to Gateway Phone,	37
5.4 Building up voice communication via VIP in Dynamic IP environment	37
5.4 PLAR (hotline) connection sample	45
FXS to FXO PLAR connection:	45
FXO to FXS PLAR connection:	46
FXO to FXO PLAR connection:	47
Chapter 6 Troubleshooting Tips	48
Chapter 7 Command Line Interface	50
7.1 Connection through Serial Port	50
7.2 Connection through Telnet	50
7.3 Command Help	51
7.4 Designating IP Address	51

7.5	Designating Port Number	51
7.6	Command Reference	52
7.7	Utility Commands	53
	clrscr	53
	download	53
	help	53
	ping	53
7.8	Network Commands	54
	net reset	54
	net set gateway <i>ip_addr</i>	54
	net set http {on off}	54
	net set telnet {on off}	54
	net set ip <i>ip_addr</i>	54
	net set ip_preced <i>ip_preced</i>	55
	net set mask <i>ip_mask</i>	55
	net set speed {10 100 auto}	55
	net set user_pw <i>password password</i>	56
	net show	56
	net show hwstat	56
	net set pppoe	57
	net set dhcp	57
	net set dyndns	57
7.9	Configuration Management Commands	58
	config {activate store erase}	59
	show h323	59
	show version	60
	set h323 alias {add del} { <i>alias</i> all}	60
	set h323 allow_call_wo_gk {true false}	60
	set h323 auto_answer {on off}	61
	set h323 call_name	61
	set h323 cisco_t38	61
	set h323 display_name <i>display_name</i>	62
	set h323 dtmf_duration <i>duration</i>	62
	set h323 endpoint_reg_type {gw terminal}	62
	set h323 endpoint_prefix	62
	set h323 gk_addr <i>ip_addr</i>	63
	set h323 gk_max_tries <i>count</i>	63
	set h323 gk_mode {off manual auto}	63
	set h323 h245_term_type <i>terminal_type</i>	63
	set h323 h245_tunneling	64

set h323 imtc_dtmf {add del} <i>ip_addr</i>	64
set h323 in_fast_start {on off}	64
set h323 master_delay	65
set h323 nat_call {on off}	65
set h323 out_fast_start {on off}	65
set h323 rtp_port_base <i>port_base</i>	65
7.10 Voice Coding Profile Configuration Commands	66
7.10.1 Common Coding Profile Configuration Commands	66
set coding <i>profile_id</i> coding_type <i>coding_type</i>	66
set coding <i>profile_id</i> cp_tone_detect {on off}	67
set coding <i>profile_id</i> fax_tone_detect {on off}	67
set coding <i>profile_id</i> usage {voice fax} {on off}	67
7.10.2 Voice Coding Profile Configuration Commands	68
set coding <i>profile_id</i> adaptive_playout {on off}	68
set coding <i>profile_id</i> dtmf_relay {on off}	68
set coding <i>profile_id</i> max_delay	68
set coding <i>profile_id</i> min_delay	69
set coding <i>profile_id</i> nom_delay	69
set coding <i>profile_id</i> vad {on off}	69
set coding <i>profile_id</i> vad_thresh	69
set coding <i>profile_id</i> vif	69
7.11 Dial Plan Management Commands	70
Database Update Control Commands	72
atpm done	72
atpm erase	72
atpm purge {all addr dest hunt}	72
atpm req	72
atpm restore	72
atpm store [erase]	73
Destination Table Management Commands	73
atpm dadd <i>dest_id</i> port <i>port#</i>	73
atpm dadd <i>dest_id</i> h323 <i>dest_ip_addr</i> [<i>ip_port</i>]	73
atpm ddel <i>dest_id</i>	74
atpm dfind <i>dest_id</i>	74
atpm dlist	74
Hunt Group Table Management Commands	75
atpm hadd <i>hunt_group_id</i> {1 2} <i>dest_id</i> [<i>desi_id2</i>] ...	75
atpm hdel <i>hunt_group_id</i>	75
atpm hfind <i>hunt_group_id</i>	75
atpm hlist	75
Address Table Management Commands	76
atpm aadd <i>tel#</i> <i>min_digits</i> <i>max_digits</i> <i>hunt_group_id</i> <i>prefix_strip_len</i> [<i>prefix#</i>]	76
atpm adel <i>tel#</i>	76
atpm afind <i>tel#</i>	77
atpm alist	77

System Commands	77
atpm slist	77
atpm sys <i>dial_time 1st_digit_wait inter_digit_wait [dial_term_digit]</i>	78
7.12 Tel Commands	78
tel show pcm_gain_level	78
tel show port [<i>port#</i>]	78
tel show ring_freq	78
tel set pcm_gain_level {1 2 3 4 5}	79
tel set ring_freq {1 2 3 4}	79
7.13 E & M Signaling Commands	79
E&M Common Signaling Configuration Commands	79
set port <i>port</i> em clear_conf_detect	79
set port <i>port</i> em clear_conf_wait_max	80
set port <i>port</i> em clear_detect	80
set port <i>port</i> em connected_min	80
set port <i>port</i> em dial_tone	81
set port <i>port</i> em disable_hangup	81
set port <i>port</i> em guard_all	81
set port <i>port</i> em guard_out	81
set port <i>port</i> em offhook_db	82
set port <i>port</i> em onhook_db	82
set port <i>port</i> em size_detect	82
E&M Immediate Start Signaling Configuration Commands	83
set port <i>port</i> emi glare_report	83
set port <i>port</i> emi wait_dsp_ready	83
E&M Delay Start Signaling Configuration Commands	83
set port <i>port</i> emd in_delay_max	83
set port <i>port</i> emd in_delay_min	84
set port <i>port</i> emd in_digit_ign	84
set port <i>port</i> emd out_delay_check	84
set port <i>port</i> emd out_delay_dur_max	84
set port <i>port</i> emd out_delay_dur_min	85
set port <i>port</i> emd out_intg_check	85
E&M Wink Start Signaling Configuration Commands	85
set port <i>port</i> emw in_wink_digit_ignore	85
set port <i>port</i> emw in_wink_dur	86
set port <i>port</i> emw in_wink_wait_max	86
set port <i>port</i> emw in_wink_wait_min	86
set port <i>port</i> emw out_wink_dur_max	86
set port <i>port</i> emw out_wink_dur_min	87

set port <i>port</i> emw out_wink_wait_max	87
7.14 Obsolete Commands	87
Chapter 8 Upgrading and resetting VIP	88
8.1 Firmware upgrade	88
TFTP server configuration	89
Trouble Shooting Tips	92
8.2 CLI Commands in Download Mode	93
help	93
quit	93
set ip <i>ip_addr</i>	93
set gateway <i>ip_addr</i>	93
set mask <i>ip_mask</i>	94
start	94
8.3 Restore default configuration	94
System configuration default parameters	94
Dialplan configuration default parameters:	96
Appendix A Technical Specifications	97
A.1 VIP Technical Specifications	97
A.2 FXO Card Technical Specifications	99
A.3 FXS Card Technical Specifications	99
A.4 E&M Card Technical Specifications	100
A.5 Console Port	100
A.6 LAN Port	100
A.7 FXO Port Pin Assignments	101
A.8 FXS Port Pin Assignments	101
A.9 E&M Pin Assignment	101
Appendix B CLI Commands	103
B.1 Normal Mode Commands	103
B.2 Download Mode Commands	104
Appendix C Factory Default Settings	105
Appendix D Worksheets	107
D.1 IP Parameters	107
D.2 ATPM Destination Table	108

D.3	ATPM Hunt Group Table	110
D.4	ATPM Address Table	111
Index		112

Chapter 1 Overview

This chapter gives an overview of PLANET Internet Telephony Gateway - VIP-000/200/400 and a detailed product description of features and capabilities.

1.1 Features

Via growth of Internet technology, Internet telephony service plays and turns into a cost-effective and highly reliable substitution system of the old-time traditional PBX system. PLANET VoIP (Voice over IP) system – VIP-000/200/400 offer toll quality voice and real-time fax data over IP networks. With optimized H323 architecture, PLANET VIP series are ideal solution for various VoIP applications such as Headquarter and Branch Office communication, and IDD cost-effective solution. With its intuitive user-friendly interface, PLANET VIP series may be installed easily conveniently, and dramatically down cost the huge amount of IDD fee.

With embedded, efficient Real-Time Operating System, VIP series provides efficiency and feature enhancement capabilities; being programmed with updated firmware users may have the most flexibility and functionality to meet different kind of application requirement. It comes equipped with remote management capabilities, configurable signaling to work with PBX, KTS, and/or telephone. Building on state-of-the-art advanced VoIP related technology. PLANET VVIP series offers various features: echo cancellation, Voice Activity Detection (VAD) , Comfort Noise Generation (CNG) , lost packet recovery algorithms and optimized voice and FAX coders to bring users superior voice quality, and best compatibility with major Internet telephony service providers..

1.2 Networking Protocols

VIP supports several industry-standard networking protocols required for voice communication. The following table describes these protocols.

Networking Protocol	Description
Internet Protocol (IP)	IP is a messaging protocol that addresses and sends packets across the network. To enable IP protocol, VIP must have a static IP address, subnet, and gateway assigned to it.
Voice over IP Protocol (VoIP)	VoIP enables VIP to transfer voice communications over an IP network. VIP employs ITU-T H.323 protocol for setting up call with one another.
Trivial File Transfer Protocol (TFTP)	TFTP allows you to transfer files over the network. VIP implements a TFTP client allowing you to download new revision firmware from a TFTP server. The TFTP client requires a TFTP server in your network.
Real-Time Transport (RTP)	RTP is a standard for transporting real-time data over IP network. VIP uses RTP protocol to send digitized and compressed voice packets.

1.3 Package Contents

The contents of your product should contain the following items:

- Internet Telephony Gateway 19" rack mountable version
- 90-240V AC power cord (VIP-000), AC-DC power adapter (VIP-200/400)
- 9-pin straight through RS-232 cable
- Rack mount brackets (2) and screws (4) (VIP-000 only)
- Quick Installation Guide
- User's Manual CD

1.4 Front Panel

The front panel of VIP contains a RJ-45 Ethernet port, one DB9 RS-232 interface port, a push button and 16 LED indicators. The following figure illustrates the front panel of VIP.



Figure 1-1 VIP-000 Front Panel



Figure 1-2 VIP-200 Front Panel



Figure 1-3 VIP-400 Front Panel

LED Indicators

The LED indicators on the front panel display the current status of VIP as described in the following table:

Indicator	Color	Activity	Indication
PWR	Green	On	Power is supplied to the gateway.
SYSTEM	Green	Blinking	The system is running. (Heartbeat LED)

LAN • ACT • 100M • LNK • COL	Green Green Green Green	On On Off On On	Data is presented on LAN. The gateway is connected to LAN at 100Mb/s. The gateway is connected to LAN at 10Mb/s. The gateway is connected to LAN. Data collision is occurring on the network connection.
Slot A Slot B Slot A/ Slot B	Green Green	On On Blinking	A slide-in module is plugged into slot A. A slide-in module is plugged into slot B. The system is updating the firmware.
Slot A/B Channels 1-4 (For VIP-200: 2 channels)	Green	Off On Blinking	The line is idle. The line is being used. The line is ringing.

Ports

VIP is equipped with an Ethernet interface with 10/100 Mbps auto-negotiation capability. The Ethernet interface port is located on the front panel. In addition to the Ethernet interface port, there is a 9-pin RS-232 interface port on the front panel. Their functions are described below:

Port	Label	Function
RJ45	LAN	Connecting VIP to a 10/100 Mbps Ethernet network
9-pin RS-232	User Console	Connecting VIP to a VT-100 terminal or terminal emulator for configuring VIP

Reset Button

There is a push button located behind a small hole next to the SYSTEM LED. **This button allows you to reset VIP or force VIP to enter firmware upgrade mode.**

Reset

Push a small, stiff object into the hole until the SYSTEM LED stops blinking, then release the button.

Force firmware download mode:

Powering on the gateway while pressing down the button for **5** seconds forces VIP to enter download mode

1.5 Rear Panel

The rear panel of VIP-000 has two slots allowing the installation of up to two Telephony-Interface-Modules (TIM) . Each module is equipped with 4 telephony interface ports. Depending on the type of the telephony interface module, the telephony interface ports may be connected to telephony devices, such as PBX, KTS, and telephone sets of central office. VIP-200 equips two FXS ports for

and VIP-400 equips with two FXO and two FXS ports. In addition to the TIM slots (ports), there is an AC power receptacle and a power switch (power adapter: VIP-200/400) on the rear panel.

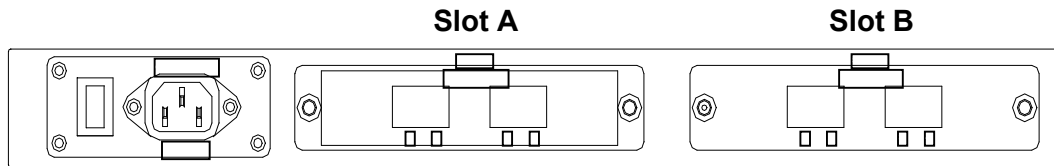

Figure 1-4 VIP-000 Rear Panel



Figure 1-5 VIP-200 Rear Panel

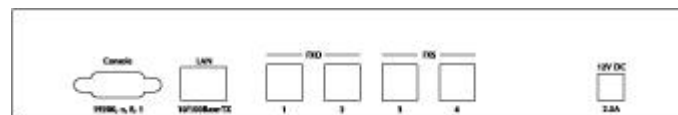

Figure 1-6 VIP-400 Rear Panel

Chapter 2 Installing VIP

This chapter gives information on how to install VIP.

2.1 Network Requirements

For VIP to successfully operate in your network, your network must meet the following requirements:

1. A working 10/100 Base-T Ethernet. VIP connects to Internet via an Ethernet LAN.
2. IP network that supports gateway, and subnet mask. You'll need a static IP address to assign VIP.

2.2 Installing VIP

VIP can be used in a desktop configuration or mounted in a standard 19-inch rack enclosure (VIP-000 only). Ensure that VIP is placed in a clean, well-ventilated, and vibration-free environment.

When VIP is placed on a desktop, be certain that the unit is placed on a sturdy, flat surface, near a grounded power outlet. At least three inches of clearance must be provided on both sides of VIP for well ventilation.

2.3 Installing the telephony interface module (VIP-000 only)

VIP allows the installation of up to two TIMs. The following steps illustrate how to install a TIM:

1. Unfasten the two screws holding the cover of the TIM slot A on the rear panel.
2. Remove the cover.
4. Before proceeding further, wear a grounded wrist strap.
5. Remove the TIM from its static-free bag. Holding the module such that the metal bracket is facing toward you.
6. Carefully align the edge of the module facing away from you with the slide-in guide inside VIP, and insert the module into the slide-in slot until it is fully seated.
7. Fasten the screws on the module.
8. Repeat step 1 through 6 for slot B if you have two TIMs. If you have only a single TIM, be certain to install it in slot A, otherwise, VIP won't function.

2.4 Connecting to the telephony devices

VIP-000 supports three types of TIM. One is FXO, FXS and the other is E&M. Each module has four ports for connecting to telephony devices. VIP-200 equips two FXS interface for connecting to regular analog telephone sets or FAX machine. VIP-400 equips two FXO and two FXS interfaces to

have the great flexibility of PBX connection (FXO), and telephone or FAX machine connection (FXS).

VIP-FXO module is designed for connecting to PBXs (extension line) or central office switches (CO line).

VIP-FXS module is designed for connecting to analog telephone sets or G3 fax machines. Connecting the telephony devices to the appropriate RJ11 ports on the TIM.

VIP-E&M module is designed for connecting to equipment (such as PBX or channel bank) providing the tie-line connection, type V, 4-wire. Connecting the tie-line port to the appropriate RJ45 port on the TIM.

Warning: *connection of incorrect telephony devices to the ports on the TIM can cause permanent damage to the TIM and/or VIP.*

2.5 Connecting to the Network

The RJ45 network port on the front panel supports 10/100 Mbps half-duplex connection to Ethernet Network. You can use either category 3 or 5 straight-through UTP cable for 10 Mbps connections, but use Category 5 for 100 Mbps connections. To connect to Ethernet, insert one end of the Ethernet cable to the RJ45 port on the front panel of VIP and other end of the cable to an Ethernet switching hub or repeater hub.

2.6 Providing Power to VIP

To provide AC power to VIP complete the following steps:

1. Turn the power switch on the rear panel of VIP to the off position.
2. Connect one end of the power cord that came with VIP to the power receptacle on the rear panel.
3. Connect the other end of the power cord to an AC power outlet.
4. Turn the power switch on. VIP will perform power on self-test. After completing the self-test, the SYSTEM LED blinks continuously and the TIM indicators on the front panel will turn on.

2.7 Assigning IP address to VIP

The IP address is the unique logical address identifying each IP node, such as VIP, on an IP network. An IP address is a 32-bit number expressed as four decimal numbers from 0 to 255 separated by periods. VIP needs a static IP address and be aware of the subnet mask and default gateway (typically a router) of your network to be able to send to and receive data from the IP network. Consult your network manager to obtain a unique and static IP address for VIP, the IP subnet mask and default gateway of your network, and fill out the work sheet in Appendix D before configuring the gateway. Procedures for assigning IP address, default gateway and subnet mask is available in Chapter 4.

Chapter 3 VIP Concepts

VIP enables the transmission of voice and fax traffic over any IP network by digitizing voice and fax signals, encapsulating the information within IP packets, and then sending the packets across the IP network

3.1 How VIP Operates

1. The TIM inside VIP digitizes analog voice signals at 8 Kbps.
2. VIP system software handles the:
 - Capture of telephone number presented as DTMF tones.
 - Mapping the telephone number to the IP address of remote VIP.
 - Setting up calls with remote VIPs utilizing H.323 call control protocol.
 - Digitizing, compressing and encapsulating the voice into IP packets and transmission of the IP packets onto the Ethernet LAN.
3. A router attached to the LAN forwards the IP packets across the WAN, where they will be received by another VIP at the remote.
4. The process is reversed at the remote VIP.

3.2 ATPM

To allow you to easily dial a telephone or fax on the network, VIP maps a series of dialed digits to the IP address of the remote VIP whose phone or fax you are calling. This mapping information is contained in a database inside each VIP called the dial plan.

Based on the dial plan the Address Translation and Parsing Manager (ATPM) inside VIP translates telephony numbers to IP addresses of remote VIPs. The ATPM collects telephone number dialed by users, decides whether the dial string is part of the dial plan and, if it is, maps it a remote VIP. When the call is set up to the destination, a substring of the original dial string will be sent along to the remote VIP.

3.3 Destination

The destination is where a call is terminated. Typically, for inbound calls from IP network, VIP terminals the call at one of the telephony ports. The destination for the call is the telephony port where the call terminated. For calls initiated from telephony ports, VIP forward the call to a remote VIP via IP network, and the remote VIP terminal the call. The destination of the call is the remote VIP.

3.4 Hunt Group

Instead of directly mapping a phone number to a destination, the ATPM first maps the phone number to a group of destinations known as a Hunt Group. A hunt group is a group of destinations that are equivalent. For example, the customer support group of a company might have 20 people who can handle support calls. Access to customer support is through a single phone number but the next available support person is actually connected upon each incoming call. These 20 phones would be configured as a hunt group. A hunt group consists of a phone number and a list of destinations (members of the group). When an incoming phone number matches the phone number of the hunt group, VIP attempts to terminate the call at each of the destinations in the hunt group, one at a time until a call is successfully completed.

Every destination that can be reached by dialing a phone number is a member of at least one hunt group. When an address is presented to ATPM for lookup, the output is a hunt group ID number. As a second step, the hunt group ID is presented to ATPM to get the list of members. To effectively bypass the hunt group feature, simply make a unique hunt group for each destination and one member in each hunt group.

3.5 Dial Plan

The dial plan is a database inside VIP for the ATPM to map telephony numbers users dialed to the IP address of remote VIPs. The dial plan consists of the destination table, hunt group table and the address table. Users need to setup these tables, so that VIP knows how to setup calls with remote VIPs.

Address Table

The address table maps a phone number to a hunt group. The table contains entries that specify the following information:

- Telephone number
- The hunt group the phone number maps to.
- The minimum number of digits to collect before the ATPM starting address lookup.
- The maximum number of digits the ATPM collects before it considers the dial string is complete.
- Number of digits forward to the destination.

Address table sample:

Address Entry	Hunt Grp_Id	Min. Digits	Max. Digits	Prefix strip	Prefix Address
200	1	3	3	0	None
201	3	3	3	0	None
899	11	3	3	0	None
8	11	3	3	0	None
0	5	1	1	0	None
03	5	10	10	2	"0"

Hunt Group Table

The hunt group table maps a hunt group to a list of destinations.

Hunt group sample

Group id	Type	#Members	Member ids
1	2	1	1
3	2	1	2
5	2	1	4
11	2	1	11

Destination Table

The destination table maps a destination to a telephony port or the IP address of a remote VIP.

Destination table sample

Dest id	Mode	Destination
1	Local	PORT = 0
3	Local	PORT = 2
5	Local	PORT = 4
11	H.323	Dest = 192.168.0.55/1720 TCP
12	DNS	Dest =PLANETVIP.dyndns.org /1720 TCP

3.6 DTMF Relay

Voice from PSTN is compressed by VIP before sending across the IP network and then decompressed by the destination VIP. The voice coders supported by VIP are designed for ideally compressing and decompressing human voice. If the compression / decompression process is performed on DTMF tone which needs to be conveyed across IP network, distortion might be too significant to be not cognizable in the receiving end. To overcome the shortcoming that the voice coders can not perfectly encode DTMF tone, VIP encodes DTMF tone into special packets. The packets are then sent to the destination VIP via a separate IP connection. The destination VIP decodes the packets, generates the DTMF tone, and then sends the tone to the PSTN. The way VIP handles DTMF tone is so called DTMF relay.

VIP handles DTMF relay per H.323 specifications. Certain third party VoIP devices may handle DTMF relay per IMTC standard. For VIP to interoperate with those VoIP devices, users need to specify which remote VoIP devices uses IMTC conforming DTMF relay technique. Refer to CLI command set `h323 imtc_dtmf {add|del} ip_addr` on Chapter 8 for detailed information on how to select DTMF relay mode.

3.7 Voice Codecs

Voice codecs supported by VIP include G.711, G.723.1 5.3kbps, G.723.1 6.3kbps and G.729 AB. When setting up a call, two VIP automatically negotiate with each other until an agreed upon codec is determined.

Chapter 4 Configuring VIP from a Web Browser

This chapter explains procedures for configuring VIP from the web browser.

4.1 Http setting mode

This section describes the processes for setting up Internet Telephony Gateway once it has been installed. Microsoft Explorer version 4 or higher, or Navigator version 4.5 or higher can be used in this section to view and change parameters.

PC Setup

In order to configure VIP, PC needs to have TCP/IP protocol and a compatible IP Address.

1. Connect VIP to network with a RJ-45 UTP cable. Power it on.
2. Find a PC, for example, Windows 2000. Under Windows 2000, select the *Network Neighborhood* icon on the desktop, then select *Properties*. We will see a screen like below:

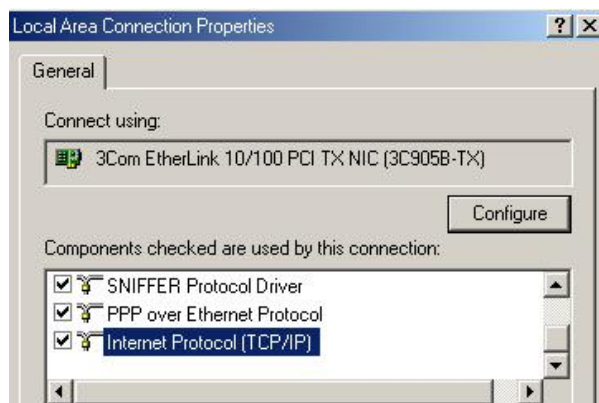

3. If a line like the one highlighted ("TCP/IP -> Network Card") is not listed, select *Add-Protocol-Microsoft-TCP/IP-OK* to add it.
4. Select *Properties* for the "TCP / IP -> Network card" entry. You will see a screen like the following:

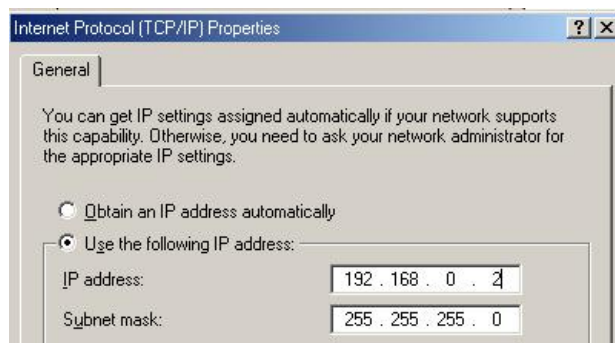

5. On the *IP Address* table, enter values as follows:

- Specify an IP address set ON.
- IP Address: 192.168.0.2
- Subnet Mask: 255.255.255.0

Restart your PC and Start your WEB browser.

6. In the Address box, enter the following:
[HTTP://192.168.0.1](http://192.168.0.1) (Default IP address in VIP-000/200/400.)
7. Press enter to confirm and you should find the screen below.

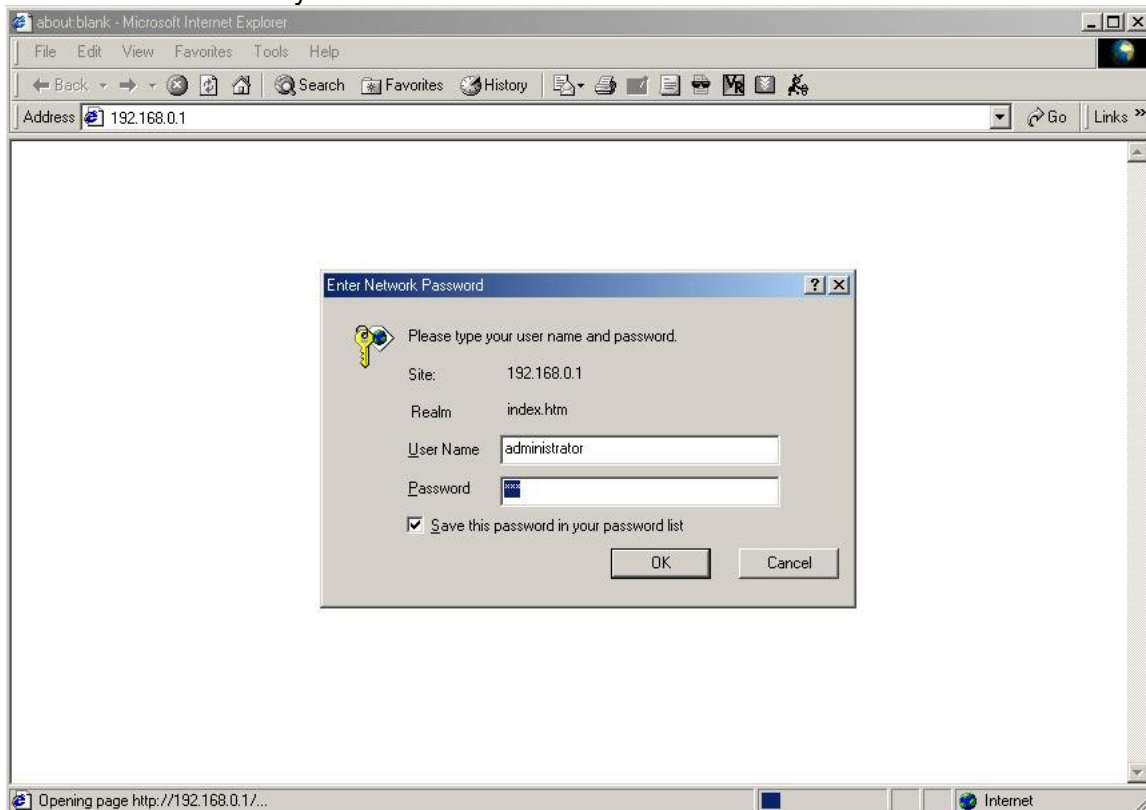

8. The User Name is **administrator** (all lower case). Password is **123**. Both **administrator** and **123** are default strings from factory). For security reasons, please change and memorize the new password after this first setup.
9. Click "OK". The main screen will appear as below.

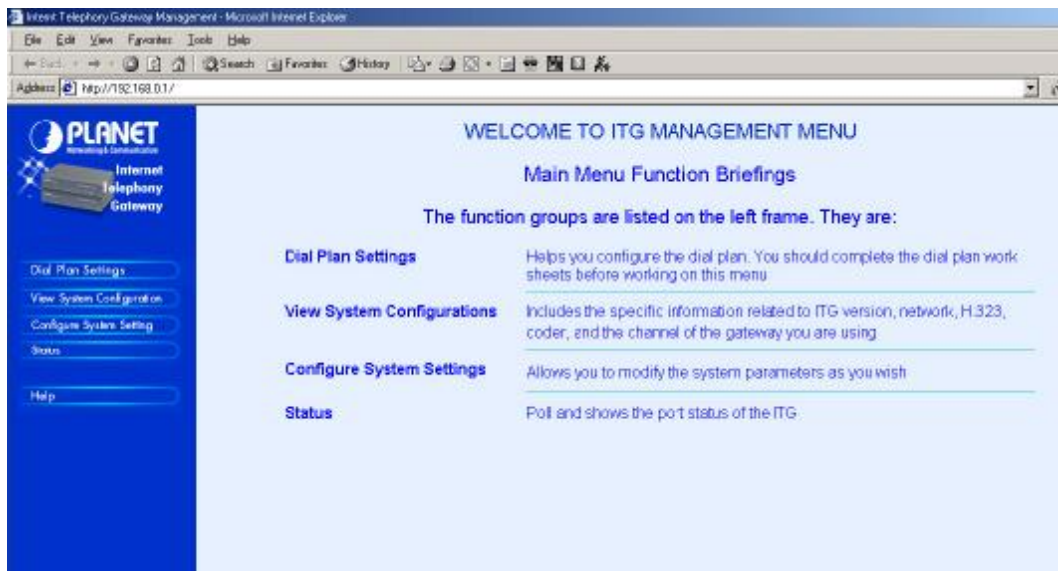

4.1.1 Dial Plan/ Dial Settings

Main Menu Function Briefings

1. **Dial Plan Settings**, which helps you configure the dial plan. You should complete the dial plan work sheets before working on this menu.
2. **View System Configurations**, which includes the specific information related to version, network, H.323, coder, and the channel of the gateway you are using.
3. **Configure System Settings**, which allows you to modify the system parameters as you wish.

Select Main Menu\Dial Plan Settings, we can find the following Dial Plan Menu.



Dial Settings	The Setup screen of the Dial Plan including: <ul style="list-style-type: none"> • Telephone Settings, which allows one to Add, Delete, Find, or List telephone numbers. • Hunt Group Settings, which allows one to Add, Delete, Find, or List hunt group settings • Destination Settings, which allows one to Add, Delete, Find, or List destination settings
Common Dial Parameters	Defines the desired total dial time, first digit wait time, inter-digit wait time, and the termination digit
Clear Dial Plan	Clears all telephone numbers, hunt groups, and destinations settings, for both old and new ones
Restore Dial Plan	Retrieves all dial plan settings from the flash while temporary settings will be cleared
Store to NVRAM	Stores all settings that you have specified permanently

4.1.1.1 Phone number

Please select **Main Menu\Dial Plan\Phone/Hunt Group/Destination Settings**, we can find **Phone/Hunt Group/Dest. Setting Menu**. We are doing VIP telephone address table management.

We can add (delete, find or list) desired telephone number mapping to hunt group at this menu.



Telephone Number	Telephone number to match. This is only part of the total dialed string.
Hunt Group ID	For each hunt group ID, you need to assign it a unique identifier between 0 and 99.
Min. Digits	Minimum number of digits to be collected before the ATPM starting matching the dial string with entries in the address table.
Max. Digits	Maximum number of digits to be collected before the ATPM starting matching the dialed string with entries in the address table.
Strip Length	The number of digits to be stripped at the beginning of the collected dial string before forwarding the string to the destination.
Append Prefix	(Optional) Digit to be added before the beginning of the collected dial string before forwarding it to the destination.

To list the phone numbers, click on "List" and select "Telephone", the screen will displayed as below:

PLANET
Internet Telephony Gateway

Main Menu
Dial Plan Settings
Dial Settings

List
Telephone
Select

Help

List All Phone Numbers Result:

Phone #	Hunt Group ID	Min. Digits	Max. Digits	Strip	Prefix
201	1	1	3	3	None
202	2	1	3	3	None
203	3	1	3	3	None
204	4	1	3	3	None

To delete / find a Telephone, select the option and telephone, you can key in the phone number to find or delete. The right bottom screen will show the result.

Delete A Telephone Number

Delete Telephone Number:

Find A Telephone Number

Find Telephone Number:

Find Telephone Number Result:

Phone #	Hunt Group ID	Min. Digits	Max. Digits	Strip	Prefix
201	1	1	3	3	None

4.1.1.2 Hunt Group

Please select **Main Menu\Dial Plan\Phone/Hunt Group/Destination Settings**, we can find **Phone/Hunt Group/Dest. Setting Menu**. We are doing VIP hunt group table management.

We can add (delete, find or list) desired hunt group ID mapping to destination ID at this menu. If you want to make the port calls to the secondary receiver, you can click one “More Destinations” you can then add the second, third receiver if the desired port/phone is busy.

We can add (delete, find or list) desired hunt group ID mapping to destination ID at this menu.

4.1.1.3 Destination IP/ Destination Channel

Please select **Main Menu\Dial Plan\Phone/Hunt Group/Destination Settings**, we can find **Phone/Hunt Group/Dest. Setting Menu**. We are doing VIP destination table management. One is **Remote Destination IP**, one is **Remote Host Name** and the other is **Local Destination Channel**.

The screenshot shows a web interface for adding a remote destination ID. On the left is a blue sidebar with the PLANET logo and navigation links: 'Main Menu', 'Dial Plan Settings', 'Dial Settings', 'Add', 'Remote_Destination_IP', 'Select', and 'Help'. The main content area is titled 'Add Remote Destination ID' and contains the following fields: 'Destination ID:' (a small text box), 'IP Address:' (a medium text box), 'Host Name:' (a long text box), and 'Company/Location:' (a medium text box). A red note states: 'Note: if both IP Address and Host Name are defined, only IP Address will be recognized.' At the bottom right are two buttons: 'Complete' and 'Clear All Changes'.

The screenshot shows a web interface for adding a local destination ID. The form is titled 'Add Local Destination ID' and contains two fields: 'Destination ID:' (a small text box) and 'Channel Number:' (a small text box). At the bottom are two buttons: 'Complete' and 'Clear All Changes'.

We can add (delete, find or list) desired destination ID mapping to Remote Destination IP, Domain Name or Local Destination Channel at this menu.

Please back to Dial Plan Menu.

4.1.1.4 Common Parameter

Please select Main Menu\Dial Plan\Common Parameter Settings

This Common Parameter Settings is the same as previous ATPM system parameters description. .

4.1.2 Clear DialPlan

Please select Main Menu\Dial Plan\Clear All Dial Plan Settings



Clear All Dial Plan Settings will clear all the settings you made before. However, the 'Clear All' is only temporary if you do not store to the Flash Memory afterwards.

That is, to restore all the settings from the Flash Memory, you need only to click on the 'Restore All Entries' on the left frame, or to reboot the system (the settings can be restored ONLY IF YOU DID NOT STORE the entries).

4.1.3 Restore DialPlan

Please select Main Menu\Dial Plan\Restore All Dial Plan Settings

Retrieve all dial plan settings from the flash memory. All temporary settings will be cleared.



4.1.4 Save to NVRAM

Please select Main Menu\Dial Plan\ Save to NVRAM

Ready to store Dial Plan settings to Flash Memory

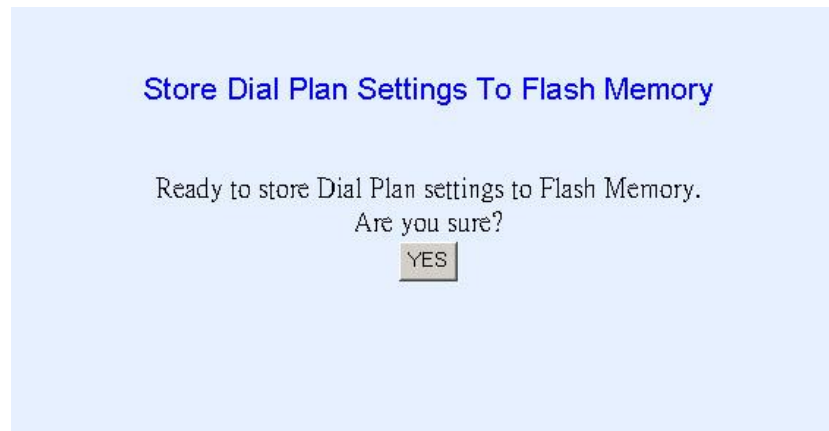

Please Back To Main Menu

4.2 View System Configurations

Please select Main Menu\View System Config.

View System Config. Function Briefings

Five options available and shown on the left frame.

Firmware Version Information	Shows the versions of each firmware component
Network Settings	Shows the IP-related settings, and the status of associated management tools
H.323 Parameter Settings	Shows the H.323-related parameters associated with the gateway
Coding Profile Information	Shows the configurations related to a specific coding profile
Channel Settings	Shows the configurations associated with a specific channel
Network Connection	Shows the status of DHCP, PPPoE, DNS

Dial Plan Settings Function Briefings

The following options are available and shown on the left frame.

Dial Settings	The Setup screen of the Dial Plan including:
----------------------	--

View System Config. Function Briefings. Six options available

1. **Firmware Version Information**, which shows the versions of each firmware component
2. **Network Settings**, which shows the IP-related settings, and the status of associated management tools
3. **H.323 Parameter Settings**, which shows the H.323-related parameters associated with the gateway
4. **Coding Profile Information**, which shows the configurations related to a specific coding profile
5. **Channel Settings**, which shows the configurations associated with a specific channel
6. **Network Connection**, which shows type of connection enabled in VIP

4.2.1 Firmware Version Information

Please select Main Menu\View System Config.\Firmware Version Info.

This will show current VIP firmware version information.

Firmware Information:

Internet Telephony Gateway (PLA) Version: 3.15
Boot Loader Version: 4.02
RTOS Version: 2.5.0/BE
H.323 Stack Version: 3.0.9.0
DSP image Version: 8.1.2.1.
TSG Version: R8.0 Gateway (Build 4)

4.2.2 H323 Parameters

Please select Main Menu\View System Config.\H.323 Parameter Settings

The H.323 Parameters Settings:

h323 display_name = Customer
h323 h245_term_type = 60
h323 rtp_port_base = 30000
h323 out_fast_start = off
h323 in_fast_start = off
h323 h245_tunneling = off
h323 cisco_t38 = on
h323 callSignalPort = 1720
h323 nat_call = on
h323 call_name =
h323 local_alert = off
h323 default_dtmf = H323 V2 Signal
No Alternate IP Defined!
h323 dns_ip = 168.95.192.1 Domain:
h323 gk_mode = off
h323 h245_timeout = 30000
h323 term_id =

4.2.3 Voice Coder Type

Please select Main Menu\View System Config.\Coder Type

The Voice Coder For Each Line Module:

Voice coder is G.723 for Line Module 1.

Voice coder is G.723 for Line Module 2.

4.2.4 Voice Coder Information

Please select Main Menu\View System Config.\Coder Information

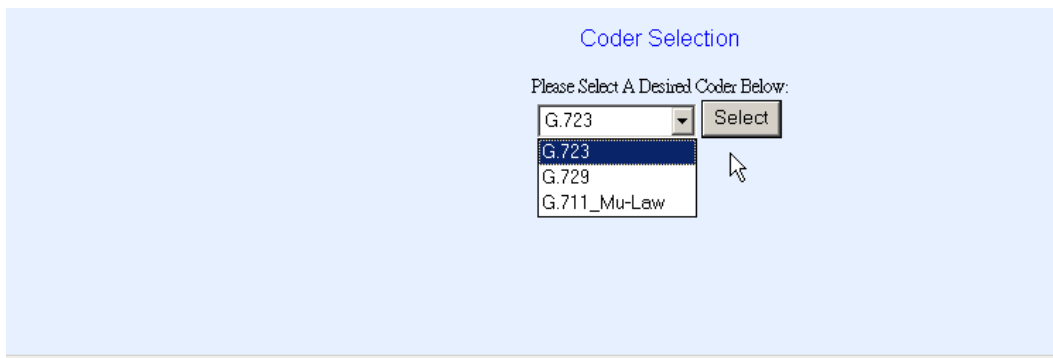

The Coder G.723 Settings:

- Configuration for coding profile id 0:
- Tx Coding = G723 6.3 kbps
- Rx Coding = G723 6.3 kbps
- Coding profile for voice
-

4.2.5 Channel Parameters

Please select Main Menu\View System Config.\Channel Parameters

This command can show the desired channel setting of VIP.



The screenshot shows a web interface titled "Channel Selection". Below the title, it says "Please Select A Desired Channel Below:". There is a text input field labeled "Channel Number:" containing the number "1", and a "Select" button to its right.

-
- Configuration for PORT (TCID) 1:
 -
 - Pref Voice coding profile: 0
 - Pref Fax coding profile: 5
 -
 - Telephony Interface Configuration:
 - Gain (RX, TX) = (*-1, \$-1)
 - Call Progress Tone Detection Control = Always on
 - Fax Tone Detection Control = Always on
 - Call Progress Tone Detection Configuration = Default
 -
 - Signaling Protocol: FXO Loop Start
 - Answer After: 2 rings
 - Caller ID Detection: ON
 - Valid Call Timer: 0 msec
 - Use user-specified CID info: No

4.2.6 Network Connection

Please select Main Menu\View System Config\Network Connection

This command can display the type of connection currently enabled in VIP.

4.2.6.1 DHCP Settings

Display current DHCP status in VIP



Command Line Interface reference:

`net set dhcp`

`net set dhcp` command configures VIP to be DHCP client in order to obtain TCP/IP related parameters from ISP while VIP is deployed in DHCP environment.

Syntax Description

<code>on</code>	Turn on DHCP client
<code>off</code>	Turn off DHCP client

If DHCP client is enabled/disabled, VIP has to be rebooted to make the DHCP service started/stopped.

4.2.6.2 PPPoE Settings

Display current PPPoE status in VIP



Command Line Interface reference:

net set pppoe

The **net set pppoe** command configures PPPoE related parameters while VIP is deployed in PPPoE environment.

Syntax Description

<i>on</i>	Turn on PPPoE client
<i>off</i>	Turn off PPPoE client
<i>username</i>	PPPoE connection username provided by ISP
<i>password</i>	PPPoE connection password provided by ISP
<i>fix_ip</i>	Fixed IP address provided by ISP

If PPPoE client is enabled/disabled, VIP has to be rebooted to make the PPPoE service started/stopped.

4.2.6.3 DDNS Settings

Display current DDNS status in VIP



The screenshot shows the PLANET Internet Telephony Gateway web interface. On the left is a navigation menu with options: Dial Plan Settings, View System Configuration, Firmware Version, H.323 Parameters, Voice Coder Type, Coder Information, Channel Parameters, Network Connection, DHCP Settings, PPPoE Settings, and DDNS Settings. The DDNS Settings option is highlighted. On the right, the 'Dyn-DNS Status' page is displayed, showing the current status as 'DDNS : disable.' and 'Dyn-DNS HOST SETTINGS :'. Below these are fields for 'dyndns serv=', 'host =', 'user =', and 'password ='. A link labeled 'Click here to change DDNS Status' is also visible.

Command Line Interface reference:

net set dyndns

DDNS service can help users to find each other in dynamic/static IP environment, and enable two VIPs call each other with registered host names. To be fully functional, DNS server **MUST** be added into H323 configuration while DDNS service is enabled.

DDNS clients supported in VIP are www.dyndns.org and www.dtdns.com currently.

If VIP DDNS client is enabled, users **MUST** register a DDNS name from the sites listed above before proceeding any further.

Syntax Description

on	Turn on DDNS client
off	Turn off DDNS client

If DDNS client is enabled, VIP has to be rebooted to make the DDNS service effective.

sub commands:

set dyndns add [serv_name] [host_name] [user_name] [password]

Adding applied DDNS name into VIP database.

Note: if multiple DDNS names are inserted, only the first one will be updated.

Syntax Description

serv_name	DDNS service server (MUST be “ dyndns ” or “ dtdns ” for now)
host_name	DDNS name registered from DDNS service provider
user_name	Username used to update DDNS account
password	Password used to update DDNS account

set dyndns delete [host_name]all

Delete specified or all DDNS name(s) configured in VIP.

This parameter must be saved in order to be effective.

4.3 Configure System Settings

Please select Main Menu\Configure System Settings

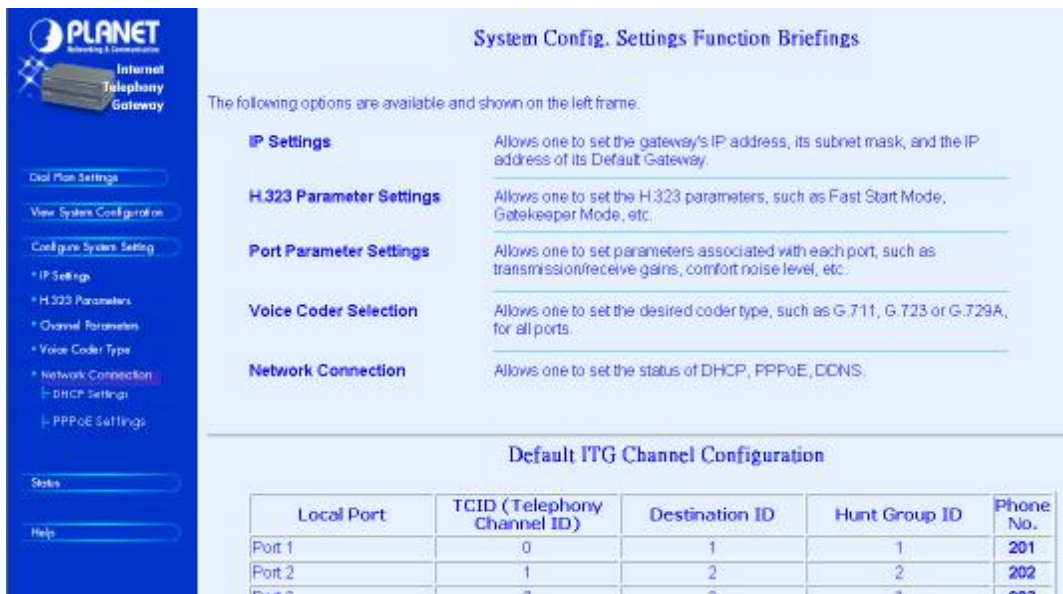

System Config. Settings Function Briefings

1. **IP Settings**, which allows one to set the gateway's IP address, its subnet mask, and its Default Gateway IP address.
2. **H.323 Parameter Settings**, which allows one to set the H.323 parameters, such as Fast Start Mode, Gatekeeper Mode, etc.
3. **Port Parameter Settings**, which allows one to set parameters associated with each port, such as transmission/receive gains, comfort noise level, etc.
4. **Voice Coder Selection**, which allows one to set the desired coder type, such as G.711, G.723 or G.729A, in a per line module base.

5. **Network Connection**, which allows user to buildup Internet connection according to different connection type, currently connection types supported in VIP are DHCP, PPPoE connections.

4.3.1 IP Settings

Please select Main Menu\Configure System Settings\IP Settings

The screenshot displays the 'IP Address Settings' page in the PLANET Internet Telephony Gateway web interface. The left sidebar contains the following navigation options: Dial Plan Settings, View System Configuration, Configure System Setting, IP Settings (selected), H.323 Parameters, Channel Parameters, Voice Codec Type, Network Connection (with sub-options for DHCP Settings and PPPoE Settings), DDNS Settings, Status, and Help. The main content area is titled 'IP Address Settings' and contains three configuration items:

- IP Address:
- Subnet Mask:
- Default IP Gateway Address: (If a Default IP Gateway is not desired, please enter 0.0.0.0)

At the bottom of the form, there are two buttons: 'Save The Changes' and 'Clear The Changes'.

This screen can setup your VIP IP Address, Subnet Mask and Default IP Gateway Address. These values will be valid after VIP reboot.

4.3.2 H323 Parameters

Please select Main Menu\Configure System Settings\H.323 Parameter Settings

There are H.323 General Parameter Settings, H.323 GateKeeper Settings, H.323 Aliases Settings.

4.3.2.1 H323 General Parameter Settings

Please select Main Menu\Configure System Settings\H.323 Parameter Settings\H.323 General Parameter Settings

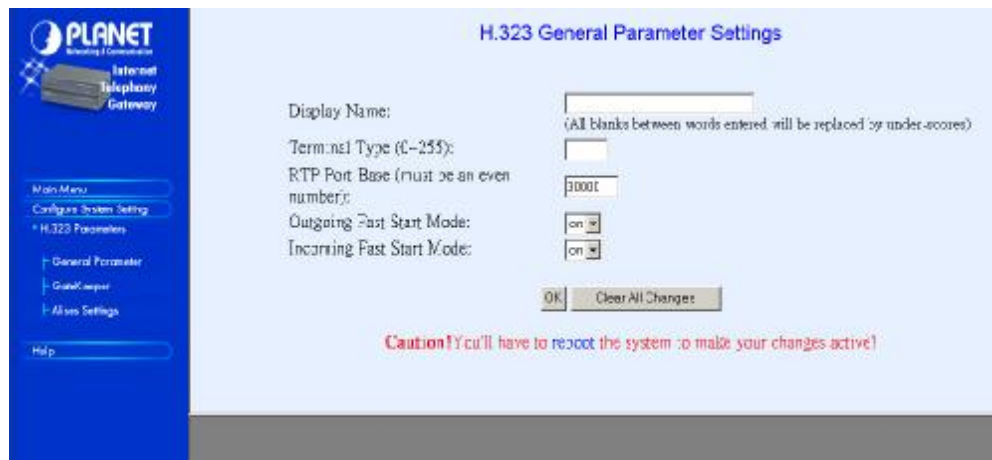

1. **Display Name:** The default string is “**Customer**”.
This field is to set the display name information that is carried in the H.323 setup messages. Up to 48 characters can be entered.
2. **Terminal Type:** The default value is **60**.
This field is to set the H.245 terminal type, which is used as part of the master/slave determination process of H.245. Typically, setting a value of less than 50 will force slave operation, and a value of greater than 200 will force the master operation.
3. **RTP Port Base:** The default value is **30000**.
This field is to select the starting port number for assignment of RTP and RTCP ports. According to the H.323 specification, RTP port number should be even in value, and the RTCP port number should be one greater than the RTP port. Typically, numbers from 0 to 1023 are reserved on most systems.
4. **Outgoing Fast Start:** The default setting is **off**.
This field is to enable or disable the Faststart mode on the outgoing side of the link.
5. **Incoming Fast Start:** The default setting is **off**.
This field is to enable or disable the Faststart mode on the incoming side of the link.
6. **NAT_Call Mode:** default is **ON**:
Enables calls from remote sites which use NAT routers with private IP networks behind.
7. **Default DTMF Mode:** H323 V2 Signal or IMTC. The default is **H323 V2 Signal**
8. **DNS IP Address:**
Specify DNS server IP address; this parameter is required while DDNS client is enabled in VIP.
9. **Call Signal Port:**
Allows users to select TCP port which H.225 listens for incoming call setup request. **(CLI only)**
10. **Local Alert:**
VIP will generate ring back tone before receiving Alerting message from remote gateway. **(CLI only)**
11. **Cisco T.38:**
This option is used for FAX transmitting while VIP interoperating with Cisco 5300. **(CLI only)**

4.3.2.2 H323 Gatekeeper Settings

Please select Main Menu\Configure System Settings\H.323 Parameter Settings\H.323 GateKeeper Settings

Gate Keeper Mode: The default setting is off. This field is to select the co-operation mode with some gatekeeper(s). Three options available:

- 8.2.1 off: disables gatekeeper co-operation,
- 8.2.2 auto: enables auto-discovery of the gatekeeper
- 8.2.3 manual: enables gatekeeper co-operation in manual operation (the gatekeeper address must be properly assigned).

The following fields must be filled up when the Gate Keeper Mode is set to either auto or manual.

Gate Keeper Address: Specify the gatekeeper address when configured to manual mode. When auto mode is desired, this field should be set to auto.

Allow Calls Without Gate Keeper: This field is to inform the H.323 stack to allow calls when the endpoint is not registered with a gatekeeper.

Registration Type: This field is to set the endpoint registration type. This specifies how the endpoint will register itself with the gatekeeper.

Max Registration Retries: This field is to control how many registration attempts will be made before the endpoint considers itself to have failed registration.

You'll have to reboot the system to make your changes active!

4.3.2.3 H323 Aliases Settings

Please select Main Menu\Configure System Settings\H.323 Parameter Settings\H.323 Aliases Settings

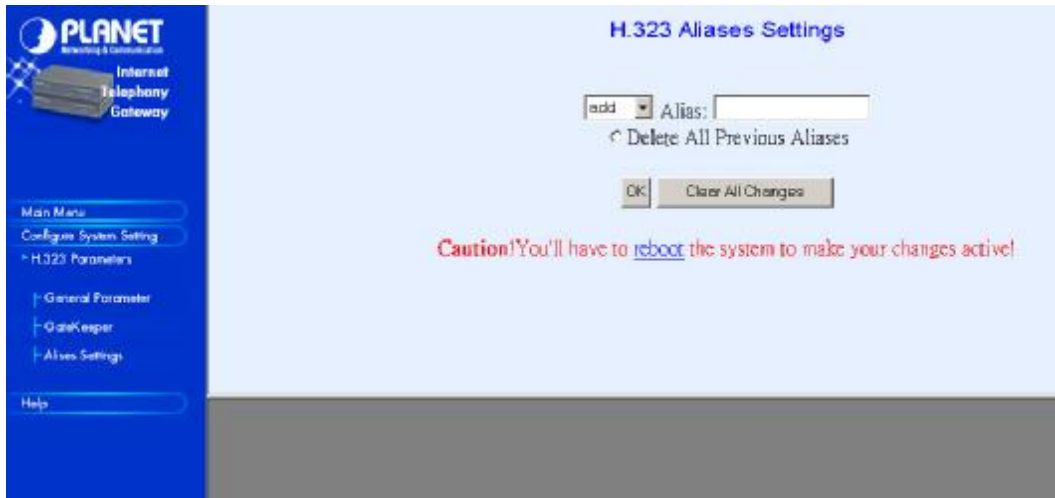

Alias: This field is to create or delete aliases that are registered with the gatekeeper.

Chapter 5 Making a Call with VIP

This chapter how to make phone calls from telephony devices connected to VIP directly or indirectly.

5.1 Making a call with VIP FXS Module

VIP has two slide-in modules. FXS module can connect to analogue phone directly, and FXO module can connect to PBX.

Connection: analogue telephone set connects to FXS module port



Operation:

1. Pick up this analogue telephone set, you can hear VIP dial tone at the telephone set
2. The related LED will be lighted at the green color when the telephone set is pick up.

For Example: If the telephone set is connected to the second port of FXS in slot B. When you pick up the telephone set, the second LED will be at the green color, it means on, in slot B of front panel.

3. We can dial the desired destination phone number at the telephone set. If the desired destination phone number is legal, VIP will play two quick address ack tones, Du Du, to destination. If the desired destination phone number is illegal, VIP will play three quick out of service tones, please check the dial plan and your desired destination phone number.

5.2 Making a call with VIP FXO Module

Connection: analogue telephone set connects to FXO module port

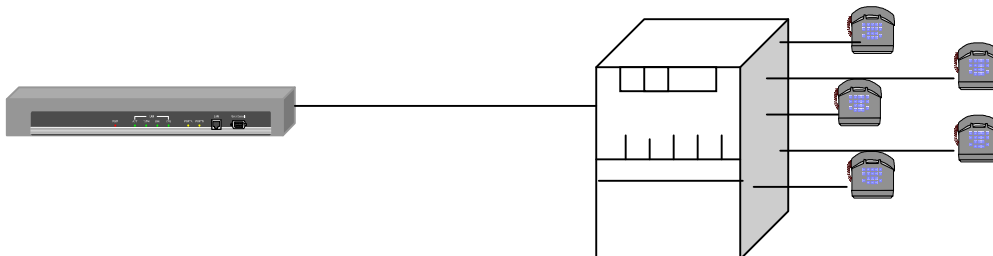

Operation:

1. Pick up this analogue telephone set, you can hear the PBX dial tone at the telephone set. In some cases, you have to dial a specific number to get the connection between telephone set and PBX.

2. Dial the phone number which is connected between PBX and VIP FXO module port.
3. When VIP is connected, the related LED will be lighted green.

For Example: If the telephone set is connected to the third port of FXO in slot A. When the PBX is connected to VIP FXO port, the third LED will be green, it means on, in slot A of front panel.

4. We can dial the desired destination phone number on the telephone set. If the desired destination phone number is legal, VIP will plan two quick sounds, "Du Du", to destination. If the desired destination phone number is illegal, VIP will plan out of service sound, please check the dial plan and your desired destination phone number.

5.3 Making a call with VIP Application Sample

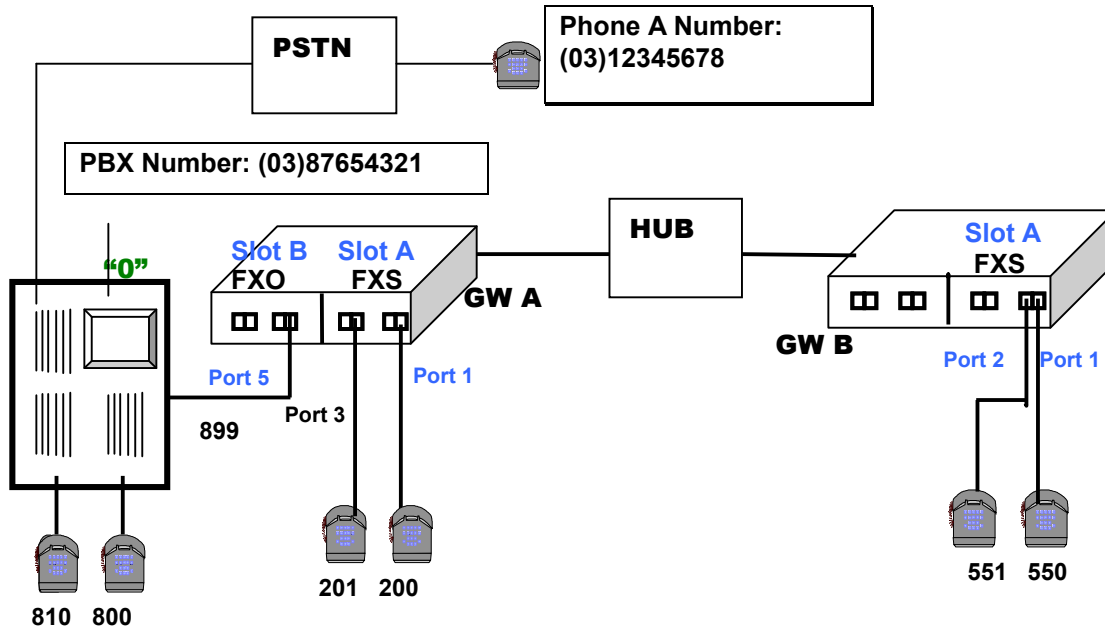

Scenario description:

There are two gateways connected by a Hub. Gateway A is configured as following:

- 1 Gateway A IP: 192.168.0.20, mask IP: 255.255.255.0, gateway IP 0.0.0.0 (virtual IP)
- 2 Slot A plugs FXS module and slot B plugs FXO module
- 3 Port 1 of FXS in slot A has a telephone set connected, its phone number is 200
- 4 Port 3 of FXS in slot A has a telephone set connected, its phone number is 201
- 5 Port 1 of FXO in slot B is connected to PBX.
 - 5.1 There are two telephone sets connected by PBX, their phone numbers are 800 and 810.
 - 5.2 PBX has a number, 899, is connected to Port 1 of FXO in slot B.
 - 5.3 PBX has an outside call to PSTN. Digit 0 is connected to outside call.
 - 5.4 Phone number: (03) 87654321 is an PBX representative number. 03 is an area code.
- 6 There is telephone set, define phone A, its number is (03) 12345678.

Gateway B is configured as following:

- 1 Gateway B IP: 192.168.0.55, mask IP: 255.255.255.0, gateway IP 0.0.0.0 (virtual IP)
- 2 Slot A plugs FXS module and slot B is empty
- 3 Port 1 of FXS in slot A has a telephone set connected, its phone number is 550
- 4 Port 2 of FXS in slot A has a telephone set connected, its phone number is 551

Gateway A and Gateway B dial plan setting

Gateway A address translation table

Address Entry	Hunt Grp_Id	Min. Digits	Max. Digits	Prefix strip	Prefix Address
200	1	3	3	0	None
201	3	3	3	0	None
899	5	3	3	0	None
8	5	3	3	0	None
0	5	1	1	0	None
03	5	10	10	2	"0"
5	11	3	3	0	None

Gateway A hunt group table

Group id	Type	#Members	Member ids
1	2	1	1
3	2	1	2
5	2	1	4
11	2	1	11

Gateway A destination table

Dest id	Mode	Destination
1	Local	PORT = 0
3	Local	PORT = 2
5	Local	PORT = 4
11	H.323	Dest = 192.168.0.55/1720 TCP

VIPB address translation table

AddressEntry	Hunt Grp_Id	Min. Digits	Max. Digits	Prefix strip	Prefix Address
550	1	3	3	0	None
551	2	3	3	0	None
2	11	3	3	0	None
899	11	3	3	0	"0"
8	11	3	3	0	None
0	11	1	1	0	None
03	11	10	10	0	None

VIPB hunt group table

Group id	Type	#Members	Member ids
1	2	1	1
2	2	1	2
11	2	1	11

VIPB destination table

Dest id	Mode	Destination
1	Local	PORT = 0
2	Local	PORT = 1
11	H.323	Dest = 192.168.0.20/1720 TCP

Making a call between gateway A and Gateway B

Case 1: Gateway Phone to Gateway Phone,

Gateway B phone 550 calls to Gateway A phone 200

Human operation at GW B Caller side	Equipment operation	Human operation at GW A Receiver Side
Pick up phone 550	1.VIP dial tone is heard. 2.the first LED will be at the green color in slot A of front panel.	
Dial 200	1.Du Du is heard 2.VoIP communication is going	
Ring back tone is heard	1.The first LED is lighting in slot A of front panel.	Phone 200 is ringing
		Pick up phone 200
Enjoy VoIP		Enjoy VoIP

The above process is the same as Gateway B phone 550 calls to Gateway A phone 201, 800 and 801.

Case 2: Gateway Phone to PSTN Phone,

Gateway B phone 550 calls to phone A number (03) 12345678

Human operation at GW B Caller side	Equipment operation	Human operation at Phone A Receiver Side
Pick up phone 550	1.VIP dial tone is heard. 2.the first LED will be at the green color in slot A of front panel.	
Dial 889	1.Du Du is heard 2.VoIP Communication is going	
Ring back tone is heard	1.The first LED is lighting in slot B of GW A front panel.	
Dial 0	1.Gateway A is connected to	

	PBX outside call	
PSTN dial tone is heard	1.Gateway B is connected to gateway A by Hub 2.Gateway A is connected to PSTN	
Dial 12345678	1.PSTN communication is going	Phone 12345678 is ringing
Ring back tone is heard		Phone 12345678 is ringing Phone 12345678 picks up
Enjoy VoIP		Enjoy VoIP

The above process is the same as Gateway A phone 200 (201, 800,801) calls to phone A number (03) 12345678

Case 3: PSTN Phone to Gateway Phone,

Phone A number (03) 12345678 calls to Gateway B phone 551

Human operation at Phone A, Caller side	Equipment operation	Human operation at Gateway B phone 551, Receiver Side
Pick up phone A	1.PSTN dial tone is heard.	
Dial 87654321	1.Communication is going 2.PBX plays voice greeting	
Dial 889		
	1.The first LED lights in green color in slot B of front panel. 2.VIP dial tone is heard	
Dial 551	1.Du Du is heard 2.VoIP Communication is going	
Ring back tone is heard		
	1.The second LED is lighting in slot A of GW B front panel.	Phone 551 is ringing
		Pick up phone 551
Enjoy VoIP		Enjoy VoIP

The above process is the same as Phone A calls to phone numbers 200, 201, 800, 801 or 550

5.4 Building up voice communication via VIP in Dynamic IP environment

Previous section shows the steps how to build up an VIP-to-VIP connection in static IP address environment. This section we will shows you how to connect two VIPs in a dynamic IP address environment together via built-in PPPoE, DHCP, and DDNS clients.

Scenario I - VIP with built-in PPPoE, DHCP, and DDNS clients:

Assuming second VIP, called VIP B, located on site B with default setting as well. First of all, it is required to apply a DDNS name from <http://www.dyndns.org> respectively for VIPs on site A and site B. (For example, the names are *planetvip.dyndns.org* for VIP on site A, and *planetvip2.dyndns.org* for VIP on site B.)

planetvip.dyndns.org is applied for VIP on site A,
planetvip2.dyndns.org is applied for VIP on site B.

Other parameters on this topology :

VIP on site A has **PPPoE**, and **DDNS** clients enabled

VIP on site B has **DHCP**, and **DDNS** clients enabled.

Network topology can be shown below:

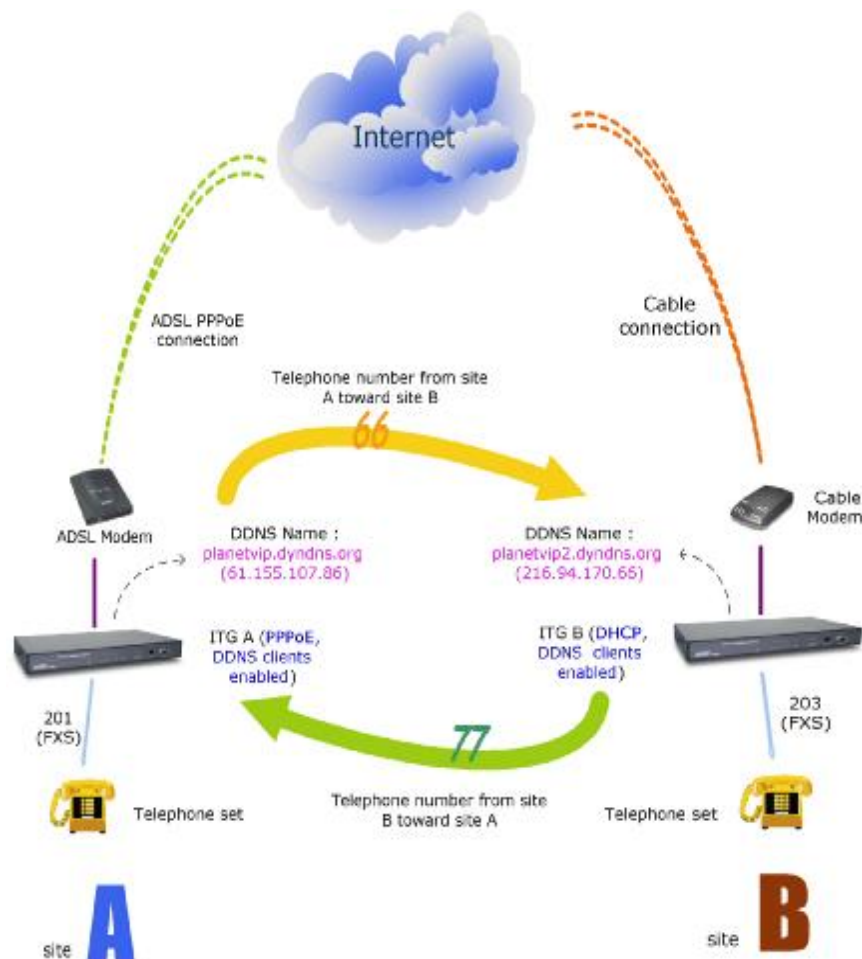

VIP configuration (ADSL PPPoE connection) on site A:

PPPoE section:

```
net set pppoe on
net set pppoe user_name [my_name]
net set pppoe pw [my_password]
net reset
```

Please fill in username/password obtained from ISP.

DNS server section:

```
set h323 dns_ip 168.95.192.1
config activate
config store
```

DNS server settings will not take effect till system reboot.

DDNS client section:

```
set dyndns add dyndns planetvip planetvip planetvip 123
config store
```

Dialplan settings:

```
atpm req
atpm aadd 66 2 8 66 2
atpm hadd 66 2 66
atpm dadd 66 dns planetvip2.dyndns.org
atpm done
atpm store
```

Create an address entry for VIP on site B

VIP configuration (cable connection) on site B:

DHCP section:

net set dhcp on , then press "y" or use command *net reset* to rebooting machine and activate this setting..

DNS server section:

```
set h323 dns_ip 168.95.192.1
config activate
config store
```

DNS server settings will not take effect till system reboot.

DDNS client section:

```
set dyndns add dyndns planetvip2 planetvip2 planetvip
456
config store
```

Dialplan section:

```
atpm req
atpm aadd 77 2 8 77 2
atpm hadd 77 2 77
atpm dadd 77 dns
planetvip.dyndns.org
atpm done
atpm store
```

Create an address entry for VIP on site A

After these modifications, users on site A are able to dial "66 + telephone number" to connect users on site B to have voice conversation. Users on site B are able to have voice communication via dialing number "77 + telephone number" toward users on site A. (please note that there is a Max digits (8) limitation of dialstring in this case, users may modify this parameter to meet different needs.)

Scenario II: VIP co works with (NAT) router which has built-in DDNS client:

In this scenario, PLANET XRT 401B is used for DDNS and DMZ features illustration

<DDNS setting screen of XRT-401B>



- a) Enable DDNS feature in XRT-401B.
- b) Insert the registered DDNS name, and username/password applied from www.dyndns.org or www.dtdns.com
- c) Click “Apply”, and check if DDNS service is effective in machine status log.

Note:

DDNS feature might come from different router vendors. Please refer to respective user’s manual for DDNS feature explanation and configuration

Please note that DDNS client in VIP series is not suggested working in NAT environment.

<DMZ setting screen of XRT-401B>

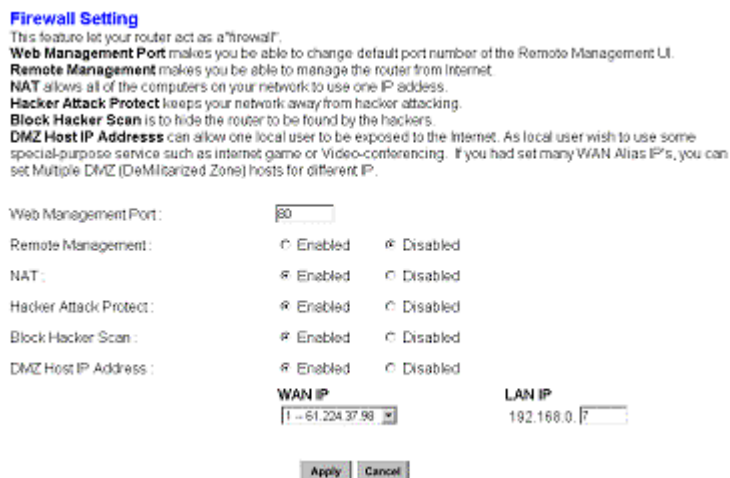

- a) Enable DMZ feature in XRT-401B.
- b) Go to “Advanced” – “Firewall” Option menu, and find the “DMZ” function.

- c) Click on the “WAN IP” tab to enable the desired IP address to destination VIP.
 d) Click “Apply” to make DMZ feature effective on VIP.

Network topology can be shown below:

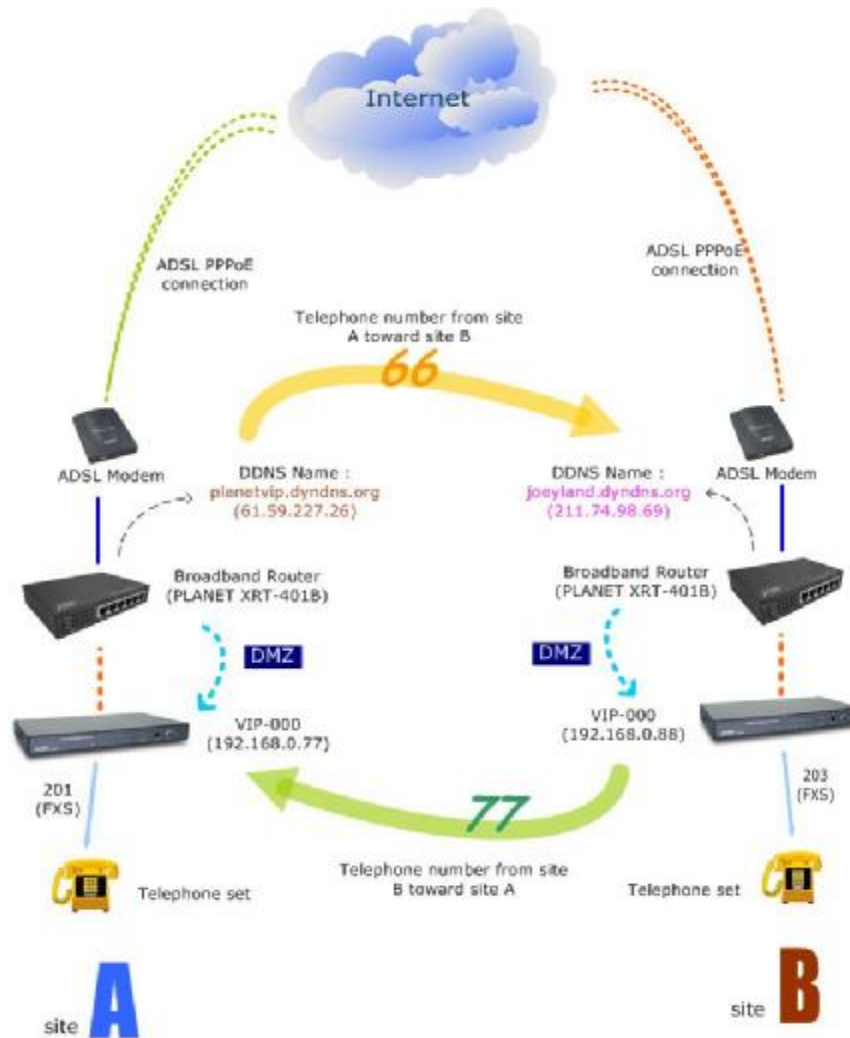

Commands used on this topology:

IP Configuration on VIP-000/200/400

- 1) **net set ip**: setup IP address on VIP
- 1) **net set mask**: setup IP mask in VIP
- 3) **net set gateway** : assign gateway IP address in VIP
- 4) **net show**: display VIP network related parameters.

H323 Configuration on VIP-000/200/400

1) **set h323 dns_ip <dns_server_ip>**:

Assign an effective DNS server IP for domain name resolution.

In this topology, DNS server is a **MUST-HAVE** parameter.

Note:

Please obtain DNS server from local ISP in order to have best efficiency for name resolution while making domain name calls.

After adding the DNS server, please use "config store " to save settings, then reboot machine to make the settings effective.

2) **set h323 nat_call on**: to have packet correctly resolved in NAT environment, this option **MUST** be enabled.

Network Deployment

DDNS service

planetvip.dyndns.org (61.155.107.86) is applied by **XRT-401B** on site A,
planetvip2.dyndns.org (216.94.170.66) is applied by **XRT-401B** on site B.

Other parameters on this connection :

VIP-000 on site A has **DMZ**, and **nat_call** enabled

VIP-000 on site B has **DMZ**, and **nat_call** enabled.

VIP-000 configuration on site A :

IP configuration :

```
net set ip 192.168.0.77
net set mask 255.255.255.0
net set gateway 192.168.0.254
net reset
```

Please refer to your application environment to fill these parameters.

DNS server section

```
set h323 dns_ip [dns_ip]
config activate
config store
```

DNS server settings will not take effect till system reboot.

Dialplan settings

```
atpm req
atpm aadd 66 2 8 66 2
atpm hadd 66 2 66
atpm dadd 66 dns planetvip2.dyndns.org
atpm done
atpm store
```

Create an address entry for VIP-000 on site B

VIP configuration (cable connection) on site B:

DHCP section:

IP configuration :

```
net set ip 192.168.0.88
net set mask 255.255.255.0
net set gateway 192.168.0.254
net reset
```

Please refer to your application environment to fill these parameters.

DNS server section

```
set h323 dns_ip [dns_ip]
config activate
config store
```

DNS server settings will not take effect till system reboot.

Dialplan section:

```
atpm req
atpm aadd 77 2 8 77 2
atpm hadd 77 2 77
atpm dadd 77 dns planetvip.dyndns.org
atpm done
atpm store
```

Create an address entry for ITG on site A

After these modifications, users on site A are able to dial "66 + telephone number" to connect users on site B to have voice conversation. Users on site B are able to have voice communication via dialing number "77 + telephone number" toward users on site A. (please note that there is a Max digits (8) limitation of dialstring in this case, users may modify this parameter to meet different needs.)

A key point in NAT-to-NAT VoIP communication, **DMZ and DDNS functionality of the NAT routers have to function CORRECTLY**, or the voice communication might have one-way communication, i.e. only WAN side voice can hear the voice from LAN side, but LAN side users cannot hear the voice from WAN side.

5.5 PLAR (hotline) connection sample

VIP is capable of automatically originate or forward an incoming call from Internet or PSTN line toward another remote destination.

In this session, three sample topological graph are provided to illustrate PLAR feature in VIP:

FXS to FXO PLAR connection:

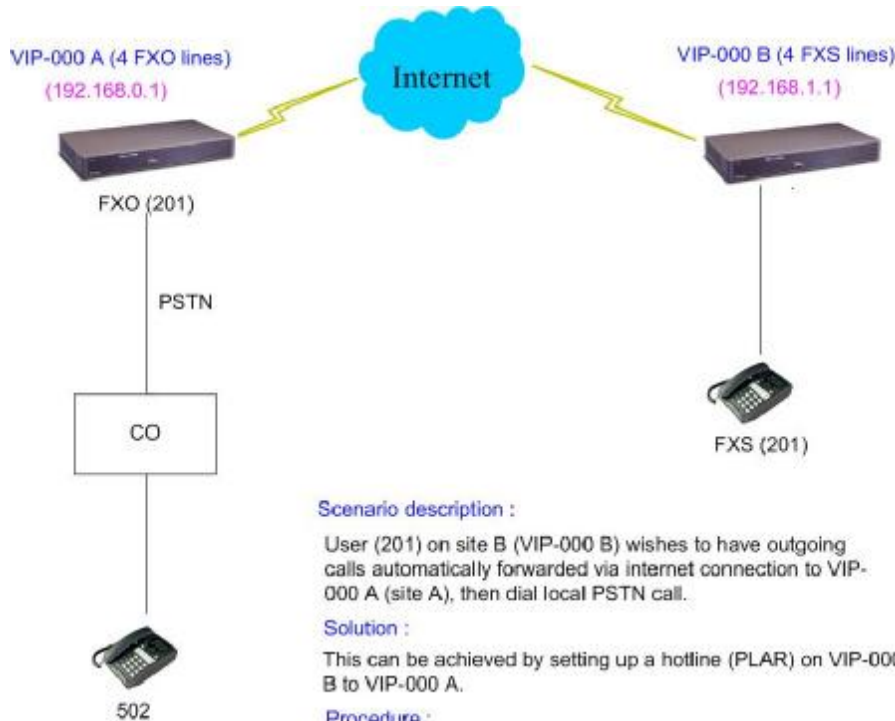

Scenario description :

User (201) on site B (VIP-000 B) wishes to have outgoing calls automatically forwarded via internet connection to VIP-000 A (site A), then dial local PSTN call.

Solution :

This can be achieved by setting up a hotline (PLAR) on VIP-000 B to VIP-000 A.

Procedure :

Log on VIP B via telnet session or console port connection, and type the following commands :

```
atpm req
atpm aadd 20 2 2 20 2 201
atpm hadd 20 2 20
atpm dadd 20 h323 192.168.0.1
atpm done
atpm store
```

This part creates an address entry for VIP A

```
set tcid 0 dial_in plar 20
config activate
config store
```

This part setup the hotline from VIP B toward VIP A

Usage :

Users on site B (VIP B) pick up the phone (201), and VIP B will automatically forward the call via internet connection toward the FXO port 201 on VIP A, then user may have a PSTN dial tone to dial local telephone number.

FXO to FXS PLAR connection:

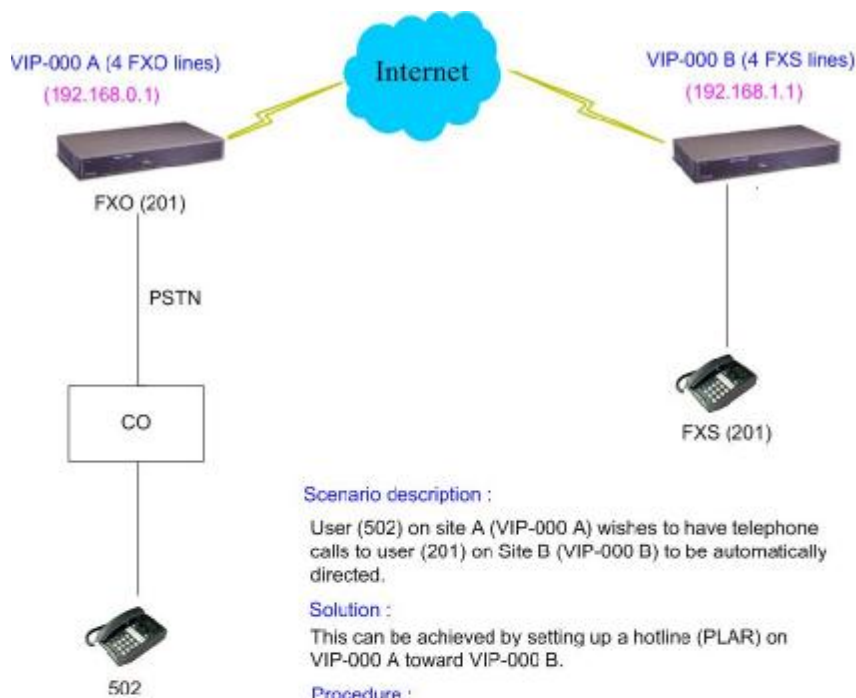

Scenario description :

User (502) on site A (VIP-000 A) wishes to have telephone calls to user (201) on Site B (VIP-000 B) to be automatically directed.

Solution :

This can be achieved by setting up a hotline (PLAR) on VIP-000 A toward VIP-000 B.

Procedure :

Log on VIP A via telnet session or console port connection, and insert the following commands :

```
atpm req
atpm aadd 20 2 2 20 2 201
atpm hadd 20 2 20
atpm dadd 20 h323 192.168.1.1
atpm done
atpm store
```

This part creates an address entry for VIPB

```
set tcid 0 dial_in plar 20
config activate
config store
```

This part setup the hotline from VIP A toward VIP B

Usage :

Users on site A (VIP A) pick up the phone (502), and dial the PSTN number to get the FXO port 201 of VIP A, then VIP A will direct the call via internet to VIP B phone number 201

FXO to FXO PLAR connection:

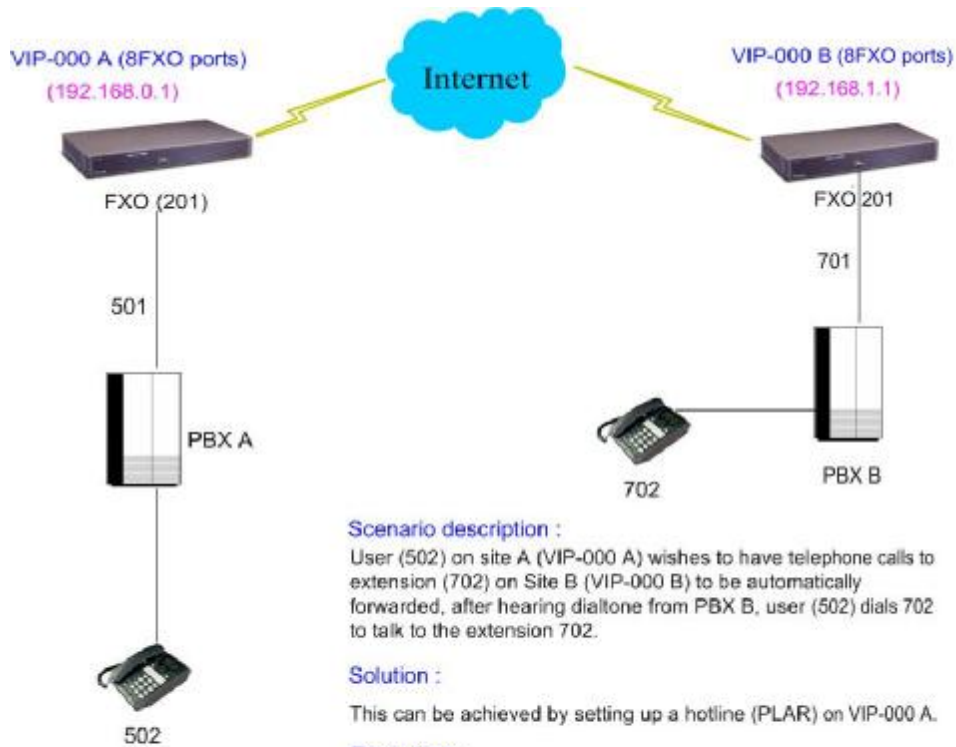

Scenario description :

User (502) on site A (VIP-000 A) wishes to have telephone calls to extension (702) on Site B (VIP-000 B) to be automatically forwarded, after hearing dialtone from PBX B, user (502) dials 702 to talk to the extension 702.

Solution :

This can be achieved by setting up a hotline (PLAR) on VIP-000 A.

Procedure :

Log on VIP A via telnet session or console port connection, and type the following commands :

```
atpm req
atpm add 20 2 2 20 2 201
atpm hadd 20 2 20
atpm dadd 20 h323 192.168.1.1
atpm done
atpm store
```

This part creates an address entry for VIPB

```
set tcid 0 dial_in plar 20
config activate
config store
```

This part setup the hotline from VIP A toward VIP B

Usage :

Users on site A (VIP A) pick up the phone (502), and dial extension 501 to connect to VIP A, at this time, VIP A will automatically connect to VIP B FXO port 201 to get the dialtone from PBX B. After the dialtone, users dial the extension number (702) to start speaking.

Chapter 6 Troubleshooting Tips

This section provides solutions for problems you may possibly encounter while installing and connecting your Internet Telephony Gateway.

Power (PWR) LED is not illuminate

1. Check the power adapter connection.
2. If the power adapter or power cord is connected to the gateway, check that the cord is securely plugged into the power socket on the rear of the console.
3. Check that the other end of the power adapter or power cord is securely plugged into the power outlet.
4. If both ends of the power cord are properly connected and there is still no power, the gateway might have a faulty power outlet, power adapter, or power cord.
5. Change to another power outlet or obtain another power adapter or power cord.

LNK LED is not illuminate

1. Check VIP was connected correctly:
 - a. Powered on
 - b. Correctly connected
2. Check if the cable connect to an end device is a standard straight through network Ethernet cable.
3. Make sure connectors at both end are securely seated.
4. Check VIP IP setting is correct

Slot A/B LED is not illuminate

1. Check if the slide-in module card plugged into the port is securely seated.
2. Make sure that the slide-in module card is not damaged.
3. If problems still occur, then the slide-in module card may not be defined.

Line module port LED is not illuminate when pick up the phone

1. Check Slot A/B LED illuminate
2. Check the RJ11 telephone line is connected correctly between phone set and line module port

There is no dial tone when pick up the phone

1. Check line module port LED illuminate
2. Check the RJ11 telephone line is connected correctly between phone set and line module port

There is an out-of-service tone when dialing destination phone number

1. Check the dial plan setting (address table, hunt group table and destination table) at the destination phone number

There is no connected tone when dialing destination phone number

1. Check the IP network (Ethernet cable, Ethernet port and GW IP setting) is connected correctly
2. Check the destination VIP and phone is available

Final Steps

If the procedures in this section have not solved the problem, reset the gateway several times by turning the power on and off. If the problem still exists, contact customer support.

Chapter 7 Command Line Interface

VIP has a built-in command line interpreter and provide users a Command Line Interface (CLI). You can configure VIP by entering commands from the CLI.

You can access the CLI from a VT-100 terminal or terminal emulator connected to the RS-232 port on the front panel or through a Telnet session.

7.1 Connection through Serial Port

The serial port of VIP is fixed at the following settings:

Baud rate	19,200
Number of data bit	8
Parity check	None
Number of stop bit	1
Flow control	None

To access VIP through the RS-232 serial port, follow the steps below:

1. Insert one end of the serial cable that came with VIP into the 9-pin RS-232 port (labeled User Console) on the front panel.
2. Insert the other end of the cable into your terminal's serial port.
3. Configure the terminal so that settings for baud rate, number of data bit, parity check, number of stop bit and flow control capability exactly match VIP's serial interface. (Refer to you terminal documentation for more information about setting up these features).
4. Press <Return> from the terminal.
5. VIP displays the following prompts on the terminal and you are ready to access the CLI then.

```
EVIP>
```

7.2 Connection through Telnet

To use Telnet, you must have previously set the IP address using the **net set ip** command for VIP. Refer to the section describing the **net set** command later in this chapter for information about setting the IP address. Up to two sessions through Telnet are possible. To access VIP from a remote host with Telnet, perform the following tasks:

Task	Prompt	Type
From the remote host, enter the telnet command followed by the IP address of VIP you want to access.	None	telnet <i>ip_addr</i>
When VIP prompts “ Login: ”, enter the user name “ administrator ”	Login:	administrator
When VIP prompts “ Password: ”, enter the password. The default password is “ 123 ” unless a password was previously established using the net set user_pw command (Refer to the section describing net set user_pw command later in this chapter for details about the setting password).	Password:	<i>password</i>

Upon successfully entered the password, VIP displays greeting message and the following prompts and you are ready to access the CLI commands.

ITG>

7.3 Command Help

Help for commands is provided by the CLI. Type **help** to see a listing of the top-level commands. On most cases, if you enter a command using the wrong number of arguments or inappropriate arguments, the CLI will give further usage.

7.4 Designating IP Address

Some commands require an IP address, which must be designated in a standard format. The IP address format is 32 bits, written as four octets separated by periods (dotted decimal format) that are made up of a network section, an optional subnet section, and a host section, as shown in the following example:

192.168.0.1

7.5 Designating Port Number

Some commands require a telephony port number. VIP designates the first port on TIM slot A as port number 0, the 2nd port as port number 1 and so on. When a TIM is installed in slot B, the first port is designated as port number 4, the 2nd one is designated as port number 5 and so on.

7.6 Command Reference

The following table list the CLI command in alphabetic order.

Command	Description
atpm	Dial plan management command
clrscr	Clear screen
config	Configuration management command
download	Download new revision code image from TFTP server
help	Display help screen
net	Set or display network parameters
ping	Ping another Internet host
set	Set system configuration
tel	Set or display telephony port options

For the ease of understanding and explaining these commands, the commands are categorized into the following command sets and the following sections explaining each set of the commands.

Command Set	Commands	Function
Utility	clrscr download help ping	General purpose utility commands
Network	net	Commands for setting or displaying network related parameters
Configuration management	config show set	Commands for configuring VIP or displaying configuration
Dial plan management	atpm	Commands for setting or displaying dial plan
Telephony	tel	Commands for setting or displaying telephony related options

7.7 Utility Commands

clrscr

The **clrscr** command to clear the screen

Syntax Description

This command has no arguments or keywords

download

Use the **download** command to enter download mode for reading code image from a TFTP server and program it to flash memory. Refer to 0 for detailed information on how to upgrade the system software.

Syntax Description

This command has no arguments or keywords

Note

This command is available from serial interface. It is not available from Telnet unless the TFTP loader is version 3.00 or higher.

help

The **help** command lists the top-level commands.

Syntax Description

This command has no arguments or keywords

ping

The **ping** command sends Internet Control Message Protocol (ICMP) echo request packets to another node on the network.

ping *host_ip_addr*

ping -s *host_ip_addr count/timeout*

Syntax description

-s	Causes ping to send one datagram per second, printing one line of output for every response received.
host_ip_addr	The IP address or IP alias of the host.
count	(Optional) The number of packets to send
timeout	(Optional) Timeout value for the ping in millisecond

7.8 Network Commands

net reset

Use the **net reset** command to reset VIP. The CLI will prompt you to confirm the command before resetting VIP.

Syntax Description

This command has no arguments or keywords

net set gateway *ip_addr*

Use the **net set gateway** command to assign a default gateway (router) for VIP. The default gateway routes packet data outside of your IP subnet.

Syntax description

<i>ip_addr</i>	The IP address of the default gateway. IP address of 0.0.0.0 stands for no default gateway.
----------------	---

Note

The new setting will not take effect until VIP is reset.

net set http {on|off}

VIP allows you enable or disable its built-in HTTP server. Use the **net set http** command to enable or disable the HTTP server.

Syntax description

on	Enable HTTP server. This allows users to access VIP from web browser.
off	Disable HTTP server.

net set telnet {on|off}

VIP allows you enable or disable its built-in Telnet server. Use the **net set telnet** command to enable or disable the Telnet server.

Syntax description

on	Enable Telnet server. This allows users to access VIP from web browser.
off	Disable Telnet server.

net set ip *ip_addr*

Use the **net set ip** command to assign a static IP address to VIP.

Syntax description

<i>ip_addr</i>	The IP address of VIP.
----------------	------------------------

Note

The new IP address will not take effect until VIP is reset.

net set ip_preced ip_preced

VIP allows you to set the 8-bit Service Type field in the IP header for all the voice packets it sends out. The Service Type field is broken down into five subfields, among which four subfields are user configurable. This command is used to set these subfields.

net set ip_preced ip_preced [d] [t] [r]

Syntax description

ip_preced	The 3-bit PRECEDENCE subfield ranging from 0 through 7.
d	The <i>D</i> bit subfield, either 0 or 1.
t	The <i>T</i> bit subfield, either 0 or 1.
r	The <i>R</i> bit subfield, either 0 or 1.

Default

ip_preced: 0
d: 0
t: 0
r: 0

Notes

The new setting will not take effect until the VIP is reset.

net set mask ip_mask

Use the **net set mask** command to set the IP subnet mask for VIP.

Syntax description

ip_mask	The subnet mask of your network.
----------------	----------------------------------

Note

The new setting will not take effect until VIP is reset.

net set speed {10|100|auto}

VIP allows you set the link speed for its Ethernet interface. Use the **net set speed** command to set the Ethernet link speed.

Syntax description

10	Fixed the Ethernet speed at 10 Mbps
100	Fixed the Ethernet speed at 100 Mbps

auto	Enable the 10/100 Mbps auto-negotiation capability.
-------------	---

net set user_pw password password

Use the **net set user_pw** command to change the password for Telnet user.

Syntax description

password	The new password. The password must be equal to or less than 7 alphanumeric characters. It must be identically typed twice for VIP to be certain about the new password.
-----------------	--

net show

The **net show** command displays all the network settings.

Syntax Description

This command has no arguments or keywords

Example

The following example shows how to display network settings:

```
ITG> net show <Enter>
***** Net Parameters *****
PPPoE =          disabled
DYN DNS =        disabled
DHCP client =    disabled
Current active IP address = 192.168.0.1.
Current active subnet mask = 255.255.255.0.
IP precedence =   0 0 0 0
Ethernet MAC address = 00-30-4f-00-29-20
```

```
Ethernet speed setting = 10/100 Mbps auto-negotiation
USER password =         123
HTTP server =           enabled
Telnet server =         enabled
```

```
*****
ITG>
```

net show hwstat

The **net show hwstat** command displays the hardware configuration of VIP.

Syntax Description

This command has no arguments or keywords

Example

The following example shows how to display hardware configuration:

```
ITG>net show hwstat <Enter>
***** Hardware Configuration *****
Flash:   type-MX29L1611 64 sectors 64 KB/sector
RAM:     8 MB 256K x 32
LAN:     100 Mbps half duplex. Link UP
TIM slot A: type-FXS4 DSP-C549 codec-NW1034 Diag-OK
TIM slot B: type-FXO4 DSP-C549 codec-NW1034 Diag-OK
*****
ITG>
```

net set pppoe

The **net set pppoe** command configures PPPoE related parameters while VIP is deployed in PPPoE environment.

Syntax Description

<i>on</i>	Turn on PPPoE client
<i>off</i>	Turn off PPPoE client
<i>username</i>	PPPoE connection username provided by ISP
<i>password</i>	PPPoE connection password provided by ISP
<i>fix_ip</i>	Fixed IP address provided by ISP

net set dhcp

net set dhcp command configures VIP to be DHCP client in order to obtain TCP/IP related parameters from ISP while VIP is deployed in DHCP environment.

Syntax Description

<i>on</i>	Turn on DHCP client
<i>off</i>	Turn off DHCP client

net set dyndns

DDNS service can help users to find each other in dynamic/static IP environment, and enable two VIPs call each other with registered host names. To be fully functional, DNS server **MUST** be added into H323 configuration while DDNS service is enabled.

DDNS clients supported in VIP are www.dyndns.org and www.dtdns.com currently.

If VIP DDNS client is enabled, users **MUST** register a DDNS name from the sites listed above before proceeding any further.

Syntax Description

<i>on</i>	Turn on DDNS client
<i>off</i>	Turn off DDNS client

sub commands:

set dyndns add [*serv_name*] [*host_name*] [*user_name*] [*password*]

Adding applied DDNS name into VIP database.

Note: if multiple DDNS names are inserted, only the first one will be updated.

Syntax Description

<i>serv_name</i>	DDNS service server (MUST be “ <i>dyndns</i> ” or “ <i>dtdns</i> ” for now)
<i>host_name</i>	DDNS name registered from DDNS service provider
<i>user_name</i>	Username used to update DDNS account
<i>password</i>	Password used to update DDNS account

set dyndns delete [*host_name*]|*all*

Delete specified or all DDNS name(s) configured in VIP.

Syntax Description

This command has no arguments or keywords.

7.9 Configuration Management Commands

The configuration management commands allow the user to set values for system configuration parameters. In addition, it provides mechanisms to allow a user to control when new parameter values are put in use.

The CLI maintains three areas where the parameters are stored:

- Temporary
- Active
- Non-volatile Storage (NVS)

When a **set** command is entered and processed, it changes the parameter value in the Temporary area. This does not affect current operation of VIP, which is using the values in the Active area. The **config activate** command moves configuration data from the Temporary area to the Active area, where it can actually be used. Thus a user can make multiple changes in the Temporary

area using **set** commands, then put them into use with a single **config activate** command. (Note that the **config activate** command may only be used between calls, and will usually tear down any in-progress calls when invoked.)

Configuration data in the Active area is only available while VIP remains in operation. If VIP is reset, the Active area is reloaded from the data stored in NVS. Data in the Active area may be saved to NVS by entering the **config store** command.

For most of the H.323 parameter, settings won't take effect until VIP reset. To ensure the H.323 setting to take effect, it is recommended to reset VIP after changing the settings using the **set** command.

In summary:

- Use **set** commands to make configuration parameters changes in the Temporary area
- Use the **config activate** command to move the new values into the Active area, available for use
- Use the **config store** command to save the new Active values in NVS
- Reset VIP after changing H.323 settings and storing the setting to NVS.

config {activate|store|erase}

Use the **activate** command to manage the configuration data. A sequence of **set** command is typically preceded by and/or followed by the **config** command for the **set** command to become active.

Syntax description

activate	Move the configuration from temporary area to active area.
store	Store the active configuration data into non-volatile storage.
erase	Erase the configuration from non-volatile storage.

show h323

The **show h323** command displays the settings of the parameter that are related to H323 signaling protocol.

Syntax Description

This command has no arguments or keywords

Example

The following example shows how to display the H323 parameters:

```
h323 display_name = Customer
h323 h245_term_type = 60
h323 rtp_port_base = 30000
h323 out_fast_start = off
h323 in_fast_start = off
```

```

h323 h245_tunneling = off
h323 cisco_t38      = on
h323 callSignalPort = 1720
h323 nat_call      = on
h323 call_name     =
h323 local_alert   = off
h323 default_dtmf  = H323 V2 Signal
No Alternate IP Defined!
h323 dns_ip        = 168.95.192.1 Domain:
h323 gk_mode       = off
h323 h245_timeout  = 30000
h323 term_id      =

```

show version

The **show version** command displays the version of various software components of VIP.

Syntax Description

This command has no arguments or keywords

set h323 alias {add | del} {alias|all}

The **set h323 endpoint_prefix** command is used to create and delete aliases that are registered with the Gatekeeper.

Syntax Description

add	Create an alias <i>alias</i>
del	Delete a previously created alias <i>alias</i>
alias	Alias to be created or deleted
all	Delete all previously created alias. This optional applies to del only

set h323 allow_call_wo_gk {true|false}

The **set h323 allow_call_wo_gk** command is used to inform the H.323 stack to allow incoming calls from a remote VIP which is not registered with a gatekeeper.

Syntax Description

true	Allow calls from VIP that is not registered with a gatekeeper.
false	Do not allow calls from VIP that is not registered with a gatekeeper.

Default

VIP allows calls from VIP that is not registered with a gatekeeper.

set h323 auto_answer {on|off}

The **set h323 auto_answer** command is used to enable or disable early call setup connection. If disabled, the call is not set up until the user initiates the connection.

Syntax Description

on	Enable H323 early call setup connection.
off	Disable H323 early call setup connection.

set h323 call_name

This command is used to set a string that VIP will encapsulate in the H.323 Setup message it sends to a remote VoIP device when initiating a call.

set h323 call_name *call_name*

Syntax Description

call_name	Call name, up to 30 characters, to be encapsulated in the 3rd alias field of srcAddress field of the H.323 call setup message
------------------	---

Default

Null

set h323 cisco_t38

Cisco FoIP solutions support standard T.38 fax. However, they expect their peer gateways initiating Open Logical Channel (OLC) request, when it determines itself as a H.323 Master. For the ITG to be aware of initiating OLC request when interoperating with Cisco gateway, this command is provided.

set h323 cisco_t38 {on | off}

Syntax Description

on	Initiates H.323 OLC under slave mode.
off	Waits for H.323 OLC from maser under slave mode.

Default

off

set h323 display_name *display_name*

The **set h323 display_name** command is used to set the display name information that is carried in the H.323 setup messages.

Syntax Description

<i>display_name</i>	The string to be inserted into the Q.931 display information field and in the sourceAddress field 2 of the H.323 setup-UUIE .
----------------------------	---

Example

The following example sets the h323 display name as “my gateway”.

```
ITG> set h323 display_name my gateway
```

set h323 dtmf_duration *duration*

When sending dtmf, by default, the gateway will use H323 Version II standard dtmf signal except other specified (ex: IMTC_dtmf). User may specify the duration of the dtmf tone.

Syntax Description

<i>duration</i>	Duration for the DTMF tone in millisecond.
------------------------	--

Default

The default setting is 300 milliseconds.

set h323 endpoint_reg_type {gw | terminal}

The **set h323 endpoint_reg_type** command is used to set the H.323 registration type. This should not be confused with the H.245 terminal type, although the two parameters should be programmed consistently. This parameter specifies how VIP will register itself with the gatekeeper, and has nothing to do with master/slave determination.

Syntax Description

<i>gw</i>	VIP registers itself to gatekeeper as a H.323 Gateway
<i>terminal</i>	VIP registers itself to gatekeeper as a H.323 Terminal

Default

VIP registers to gatekeeper as a H.323 Gateway.

set h323 endpoint_prefix

This command is used to set the H.323 prefix that VIP uses when registering to an H.323 gatekeeper. After registering to a gatekeeper using the prefix, the gatekeeper will map all Admission Request with destination matching the prefix to VIP.

set h323 endpoint_prefix *alias*

Syntax Description

alias	H.323 alias of the prefix.
--------------	----------------------------

Default

Null

set h323 gk_addr *ip_addr*

The **set h323 gk_addr** command is used to specify the address of the gatekeeper when configured for manual mode.

Syntax Description

ip_addr	IP address of the H.323 gatekeeper
----------------	------------------------------------

set h323 gk_max_tries *count*

The **set h323 allow_call_wo_gk** command is used to control how many registration attempts will be made before VIP considers itself to have failed registration. Once this number of unsuccessful attempts have been made, VIP will only be able to place calls if **allow_calls_wo_gk** is true.

Syntax Description

count	Number of registration attempt
--------------	--------------------------------

Default

The default number of registration attempt is 2.

set h323 gk_mode {*off* | *manual* | *auto*}

The H.323 protocol allows calls to be established through H.323 gatekeeper. The **set h323 gk_mode** command is used to specify if call is establishmet through a gatekeeper.

Syntax Description

off	Disables gatekeeper operation
manual	Enables gatekeeper in manual discovery mode. The gk_addr must be set appropriately.
auto	Enables auto-discovery of the gatekeeper

Default

The gatekeeper operation is disabled.

set h323 h245_term_type *terminal_type*

The **set h323 h245_term_type** command is used to set the H.245 terminal type. The terminal type is used as part of the master/slave determination process of H.245.

Syntax Description

termnal_type

A numerical value designating the H245 terminal type. Typically, setting the H.245 terminal type to a value less than 50 will force slave operation, and a value greater than 200 will force master operation

Example

The following example sets the h245 terminal type to 60.

```
ITG> set h323 h245_term_type 60
```

set h323 h245_tunneling

In order to conserve resources, synchronize call signaling and control, and reduce call setup time, it may be desirable to convey H.245 messages within the Q.931 Call Signaling Channel instead of establishing a separate H.245 channel. This is so-called "tunneling". This command is used to set tunneling feature. **Syntax Description**

on	Turn on H.245 tunneling feature
off	Turn off H.245 tunneling feature

Default

off

set h323 imtc_dtmf {add|del} ip_addr

There are two ways VoIP gateway handles DTMF relay, per H.323 and IMTC specifications. By default, VIP conveys DTMF digits in H.323 format. The **set h323 imtc_dtmf** command is used to specify how DTMF digits are to be conveyed to a remote VoIP device.

Syntax Description

add	VIP sends DTMF digit to the remote VoIP device designated by IP address <i>ip_addr</i> in IMTC conforming format.
del	VIP sends DTMF digit to the remote VoIP device designated by IP address <i>ip_addr</i> in H.323 format.
ip_addr	IP address of the remote VIP

Default

VIP sends DTMF digits in H.323 format, unless the call is destined for a remote VoIP device whose IP address has been **set h323 imtc_dtmf added**.

set h323 in_fast_start {on|off}

The **set h323 in_fast_start** command is used to select the H.323 Faststart mode on for calls initiated from remote VIPs.

Syntax Description

on	Set H323 Faststart mode on
off	Set H323 Faststart mode off

set h323 master_delay

To be able to interoperate with certain H.323 terminals, such as Microsoft NetMeeting, the gateway can not send out H.323 open logical channel message to its counter H.323 terminal immediately after completing H.323 maser slave determination phase. This command allows users to delay sending the H.323 Open Logical Channel message to its counter H.323 terminal.

set h323 master_delay {on | off}

Syntax Description

on	Delays sending H.323 open logical channel message.
off	Sends H.323 open logical channel message upon completing H.323 maser slave determination.

Default

off

set h323 nat_call {on|off}

When VIP is installed in a network that connects to WAN via a router with Network Address Translation (NAT) feature, the NAT might block calls. The **set h323 nat_call** command is used to enables VIP to connect to remote VIPs connecting to WAN via NAT capable router.

Syntax Description

on	Enable.
off	Disable.

set h323 out_fast_start {on|off}

The **set h323 out_fast_start** command is used to select the H.323 Faststart mode on for calls making toward remote VIPs.

Syntax Description

on	Set H323 Faststart mode on
off	Set H323 Faststart mode off

set h323 rtp_port_base port_base

The **set h323 rtp_port_base** command is used to select the starting port number for assignment of RTP ports. When a calls are made to remote VIPs, an RTP port is opened for each call. VIP uses the *port_base* as the RTP port number for the first call, the next call uses the next successive port, and so on.

Syntax Description

port_base

The starting port number for the assignment of RTP port. If rtp_port_base is assigned a value of 0, the assignment of port number will be dynamic. The port number can be specified from 0 to 32767. Typically, numbers from 0 to 1023 are reserved on most systems. The recommended value is 30000.

Example

The following example sets RTP base port number to 30000.

```
ITG> set h323 rtp_port_Base 30000
```

7.10 Voice Coding Profile Configuration Commands

Coding profile is used to store coding parameters for voice and fax coding p that can be used by telephony port on VIP. VIP has built-in coding profiles, each having a unique profile ID and parameters for specific voice, fax or modem coder. Among these coding profiles, there are five may be used for voice or fax applications. The following table summarizes coding profiles available for voice and fax applications.

Coding profile ID	Coder
0	G.723 6.3 kbps voice coder
1	G.729AB voice coder
2	G723 5.3 kbps voice coder
5	Proprietary fax coder
6	G.711 μ -law voice coder
10	Standard T.38 fax coder

This session will introduce commands for setting the parameters for a particular coding profile. All the commands in this session are of the same syntax as follows:

```
set coding profile_id option [option] . . .
```

Syntax for the *profile_id* is as follows:

profile_id ID of the coding profile to be modified.

7.10.1 Common Coding Profile Configuration Commands

set coding profile_id coding_type coding_type

Syntax description

coding_type Type of the codcc as defined in the following table.

Parameter	Description
g711_mu	G.711 PCM u-law coding

g723_53	G.723.1 5.3 kbps coding
g723_63	G.723.1 6.3 kbps coding
g729ab	G.729 annex A, annex B 8kbps coding
fax_t38	Fax Relay in T.38 mode

Note: Modification will not take effect till save and next reboot.

set coding profile_id cp_tone_detect {on | off}

This command is used to specify a secondary level of control of call progress tone detection. If the call progress detection control for a telephony port is set to "As per coding profile" (refer to command "[set port port cp_tone_det_ctrl](#)"), this parameter determines if detection is to be enabled or not.

Syntax description

on	Enable call progress tone detection.
off	Disable call progress tone detection.

set coding profile_id fax_tone_detect {on | off}

This command is used to specify a secondary level of control of V.21 fax tone detection. If the fax tone detection control for a telephony port is set to "As per coding profile" (refer to command "[set port port fax_tone_det_ctrl](#)"), this parameter determines if detection is to be enabled or not. For a voice coder, fax tone detection has to be enabled, otherwise, telephony port never switches to fax mode while the voice coder is active. For a fax profile it does not matter if the fax tone detection is enabled or disabled.

Syntax description

on	Enable V.21 fax tone detection.
off	Disable V.21 fax tone detection.

set coding profile_id usage {voice | fax} {on | off}

Syntax description

Voice	The coding profile is allowed, if the parameter that follows is "on", for being used as voice coder. The coding profile is not allowed, if the parameter that follows is "off", for being used as voice coder.
Fax	The coding profile is allowed, if the parameter that follows is "on", for being used as fax coder. The coding profile is not allowed, if the parameter that follows is "off", for being used as fax coder.

7.10.2 Voice Coding Profile Configuration Commands

set coding *profile_id* adaptive_playout {on | off}

VIP has built-in voice packet buffer, which allows VIP to remove packet jitter from the incoming packet stream. VIP also implements an adaptive voice packet playback. This command is used to enable/disable the adaptive playback function for a voice coding profile.

Syntax description

on	Enable adaptive playback.
off	Disable adaptive playback.

set coding *profile_id* dtmf_relay {on | off}

VIP supports DTMF Relay, in which DTMF tones are detected during voice processing, encoded into H323-UserInfo packets and conveyed to the remote VIP via the H.323 call control band. This command is used to enable or disable the DTMF Relay feature.

Syntax description

on	Detect DTMF tones while voice session is on-going, and send detected DTMF digits to remote gateway via the H.323 call control band.
off	Do not detect DTMF tones. DTMF tones are compressed and send to remote gateway the same as regular voice frame.

set coding *profile_id* max_delay

Voice packets from network may have traversed variable path and each packets have experienced different propagation delay. To ease this phenomenon, VIP has a built-in voice packet buffer, which stores voice packets received from the network. The effect of non-uniform delay among packets is known as jitter. The voice buffer allows VIP to remove the packet jitter from the incoming packet stream before decompressing and sending the packet to telephony port for playing out. This command is used to set the size of voice buffer.

Syntax description

delay	Value in milliseconds.
--------------	------------------------

Notes

1. The maximum delay should be at least 2 packet times greater than the nominal delay. Refer to command “[set coding *profile_id* nom_delay](#)” for details about setting nominal delay.
2. The maximum delay for each coder is shown in the following table:

Coding Type	Maximum Delay
G.711 μ -law	145 ms
G.723	500 ms
G.729AB	500 ms

set coding profile_id min_delay

This command is used to set the time each voice packet is stored in the voice packet buffer before VIP playing out the packet. It is only meaningful when the adaptive playback feature is disabled. Refer to “set coding profile_id adaptive_payout” for details about adaptive playback feature.

Syntax description

delay	Value in milliseconds.
--------------	------------------------

set coding profile_id nom_delay**Syntax description**

Delay	Value in milliseconds.
--------------	------------------------

set coding profile_id vad {on | off}

This command is used to enable/disable the Voice Activity Detector (VAD) for a coding profile.

Syntax description

On	Enable VAD.
Off	Disable VAD.

set coding profile_id vad_thresh

This command is used to set threshold level for the VAD for a coding profile.

Syntax description

threshold	Value in dBm, ranging from –20 to +10.
------------------	--

set coding profile_id vif

This command is used to set the size of the Voice Information Field (VIF), in bits, for a voice coder.

Syntax description

Coding type	Sampling time	VIF
G.711 μ -law	10 ms	640
	20 ms	1,280
	30 ms	1,920
G.723	30 ms	192
	60 ms	384
G.729AB	10 ms	80
	20 ms	160

	30 ms	240
	40 ms	320
	50 ms	400
	60 ms	480

Note:

Size of the Voice Information Field (VIF), in bits, for a voice coder are related to the coding type and the rate the voice coder samples a voice frame (the packet time), as shown in the table above. **VIF sizes of a coder of values other than those shown in the table are not valid.**

7.11 Dial Plan Management Commands

Among the command sets supported by the CLI, the dial plan management commands are the most sophisticated. Some of the dial plan management commands are only allowed when VIP is in the atpm table update state. For ease of explaining, this command set is further categorized into several sub command sets.

Sub command set	Purposes	Commands	atpm table update state required?
Database update control	<ul style="list-style-type: none"> Instruct VIP to start or stop atpm table update state. Store/restore atpm tables to/from non-volatile storage Purge atpm tables Erase dial plan database from non-volatile storage 	atpm req atpm done atpm restore atpm store atpm purge atpm erase	No No Yes No Yes No
Destination table management	Manage atpm destination table	atpm dadd atpm ddel atpm dfind atpm dlist	Yes Yes No No
Hunt group table management	Manage atpm hunt group table	atpm hadd atom hdel atpm hfind atpm hlist	Yes Yes No No
Address table management	Manage atpm address table	atpm aadd atpm adel atpm afind atpm alist	Yes Yes No No
System	Manage atpm system configuration	atpm slist atpm sys	No Yes

--	--	--	--

The following sections describe each sub command set and the commands.

Database Update Control Commands

atpm done

The **atpm done** command ends the atpm table update session and re-enables the address translation.

Syntax description

This command has no arguments or keywords

atpm erase

The **atpm erase** command erases the dial plan database from the non-volatile memory.

Syntax description

This command has no arguments or keywords

atpm purge {all|addr|dest|hunt}

Use the **atpm purge** command to delete all entries from the atpm tables.

Syntax description

all	Delete all entries from atpm ddress, destination and hunt group tables.
addr	Delete all entries from atpm address table.
dest	Delete all entries from atpm destination table.
hunt	Delete all entries from atpm hunt group table.

atpm req

The **atpm req** command starts the atpm table update session. Upon starting the atpm table update session, the ATPM address translation is disabled, hence no phone call can be made, until a **atpm done** command is issued.

Syntax description

This command has no arguments or keywords

atpm restore

The **atpm restore** command restores the whole dial plan from non-volatile storage to the atpm address, destination and hung group tables.

Syntax description

This command has no arguments or keywords

atpm store [erase]

The **atpm store** command store all atpm tables into non-volatile memory.

Syntax description

erase	(Optional) Erase the non-volatile before storing the dial plan database. This option is not recommended except the very first time you use the atpm store command.
--------------	---

Destination Table Management Commands

atpm dadd *dest_id* port *port#*

The **atpm dadd *dest_id* port** command adds an local destination entry into the atpm destination table. A local destination entry is one of the telephony ports on VIP.

Syntax description

<i>dest_id</i>	Destination ID. For each destination, you need to assign it a unique identifier between 1 and 65536.
<i>port#</i>	The number of the telephony port.

Example

The following example shows how to assign ID 1 to the first telephone port on TIM slot A and add an entry in the destination table designating it.

```
ITG>atpm dadd 1 port 0 <Enter>
```

atpm dadd *dest_id* h323 *dest_ip_addr* [*ip_port*]

The **atpm dadd *dest_id* h323** command adds a h323 type remote destination entry into the atpm destination table. A remote destination entry is typically another VIP or H323 gateway.

Syntax description

<i>dest_id</i>	Destination ID. For each destination, you need to assign it a unique identifier between 1 and 65536.
<i>dest_ip_addr</i>	The IP address of the remote destination.
<i>ip_port</i>	(Optional) Base port number VIP uses to establish voice with that remote destination.

Example

The following example shows how to add a remote destination whole IP address is 192.168.0.3 to the destination table and assign an ID 200 to that destination.

```
ITG>atpm dadd 200 h323 192.168.0.3 <Enter>
```

atpm ddel *dest_id*

The **atpm ddel** command deletes an entry from the atpm destination table.

Syntax description***dest_id***

ID of a previously added destination entry to be deleted from destination table.

atpm dfind *dest_id*

The **atpm dfind** finds and display an entry in the destination table.

Syntax description***dest_id***

ID of a previously added destination entry to be displayed.

Example

The following example shows how to display a destination whose ID is 200.

```
ITG>atpm dfind 200 <Enter>
Dest id  Mode  Destination
-----
   200  H.323  Dest = 192.168.0.3/1720 TCP
OK
EVIP>
```

atpm dlist

The **atpm dlist** displays all entries in the destination table.

Syntax description

This command has no arguments or keywords

Example

```
ITG>atpm dlist
Dest id  Mode  Destination
-----
   1  Local  PORT = 0
   2  Local  PORT = 1
   3  Local  PORT = 2
   4  Local  PORT = 3
   5  Local  PORT = 4
   6  Local  PORT = 5
   7  Local  PORT = 6
   8  Local  PORT = 7
  11  H.323  Dest = 210.243.133.157/1720 TCP
OK
ITG>
```

Hunt Group Table Management Commands

atpm hadd *hunt_group_id* {1|2} *dest_id* [*desi_id2*] ...

Use the **atpm hadd** command to add an entry into the atpm hunt group table.

Syntax description

<i>hunt_group_id</i>	Hunt group ID. For each hunt group, you need to assign it a unique identifier between 1 and 65536.
<i>1</i>	Hunt type 1. Hunt type 1 hunts destination within a hunt group starting from the destination member just after the last used member.
<i>2</i>	Hunt type 2. Hunt type 2 hunts destination within a hunt group starting from the first destination member.
<i>dest_id1</i>	ID of the first destination member in the hunt group.
<i>dest_id2</i> <i>dest_id3</i> ...	(Optional)List of ID's of additional destination members in the hunt group.

Example

The following example shows how to group destination 1, 2, 3 and 4 into a hunt group, assign it hunt group ID 10, and specify hunt type 2 for this hunt group.

```
ITG>atpm hadd 10 2 1 2 3 4<Enter>
```

atpm hdel *hunt_group_id*

The **atpm hdel** command deletes an entry from the atpm hunt group table.

Syntax description

<i>hunt_group_id</i>	ID of the hunt group to be deleted from the hunt group table.
----------------------	---

atpm hfind *hunt_group_id*

The **atpm hfind** finds and display an entry in the hunt group table.

Syntax description

<i>hunt_group_id</i>	ID of the hunt group to be displayed.
----------------------	---------------------------------------

atpm hlist

The **atpm hlist** display all entries in the hunt group table.

Syntax description

This command has no arguments or keywords

Example

```
ITG>atpm hlist
Group id  Type  #Members  Member ids
-----
  1    2    1    1
  2    2    1    2
  3    2    1    3
  4    2    1    4
  5    2    1    5
  6    2    1    6
  7    2    1    7
  8    2    1    8
 11    2    1    11
OK
ITG>
```

Address Table Management Commands

atpm add tel# min_digits max_digits hunt_group_id prefix_strip_len [prefix#]

Use the **atpm add** command to add an entry into the atpm address table.

Syntax description

tel#	Telephone number to match. This is only part of the total dialed string.
min_digits	Minimum number of digits to be collected before the ATPM starting matching the dialed string with entries in the address table.
max_digits	Maximum number of digits to be collected before the ATPM starting matching the dialed string with entries in the address table.
hunt_group_id	Hung group ID for this telephone number
prefix_strip_len	The number of digits to be stripped at the beginning of the collected dial string before forwarding the string to the destination.
prefix#	(Optional) Digit to be added before the beginning of the collected dial string before forwarding it to the destination.

atpm adel tel#

The **atpm adel** command deletes an entry from the atpm address table.

Syntax description

tel#	Number of a previously added entry to be deleted from the atpm address table.
-------------	---

atpm afind tel#

The **atpm afind** finds and display an entry in the address table.

Syntax description

tel# Number of a previously added entry in the atpm table to be displayed.

atpm alist

The **atpm alist** displays all entries in the address table.

Syntax description

This command has no arguments or keywords

Example

```
ITG>atpm alist
Address      Hunt  Min  Max  Prefix Prefix
Entry       Grp_Id Digits Digits strip Address
201         1    1    3    3    None
202         2    1    3    3    None
203         3    1    3    3    None
204         4    1    3    3    None
205         5    1    3    3    None
206         6    1    3    3    None
207         7    1    3    3    None
208         8    1    3    3    None
OK
ITG>atpm done
OK
ITG>
```

System Commands

atpm slist

The **atpm slist** displays the atpm system table.

Syntax description

This command has no arguments or keywords

Example

```
ITG>atpm slist
System Info: Total dial time = 30000ms, First digit wait = 10000ms,
             Interdigit wait = 5000ms, Dial term digit = None
OK
ITG>
```

atpm sys dial_time 1st_digit_wait inter_digit_wait [dial_term_digit]

Use the **atpm sys** command to set the time constraints for collection of dial digits.

Syntax description

dial_time	The maximum time, in millisecond, allowed for entry of the entire string of dial digits. At expiration, ATPM starts address lookup.
1st_digit_wait	The maximum time, in millisecond, allowed between off-hook and when the first dial digit is entered. At expiration, ATPM considers address lookup to fail.
inter_digit_wait	The maximum time allowed between entry of each digit after the previous digit. At expiration, ATPM starts address lookup.
dial_term_digitr	(Optional) End of the dial string is declared when the digit is entered.

7.12 Tel Commands

tel show pcm_gain_level

The **tel show pcm_gain_level** command to display the gain level setting of the PCM codec's receive channel.

Syntax Description

This command has no arguments or keywords

tel show port [port#]

The **tel show port** command displays the hook state of a telephony port.

Syntax Description

port#	Number of the port.
--------------	---------------------

Default

If the port number is not specified, the CLI displays hook state of all telephony ports.

tel show ring_freq

The **tel show ring_freq** command to displays the frequency of the ring signal that VIP sends to FXS ports..

tel set pcm_gain_level {1|2|3|4|5}

The FXO ports might be connected to central office switch or PBX via local loop which may of as long as several miles. For compensating signal distortion in the local loop, VIP's PCM codec is designed in such a way that users might adjust it gain level before transmitting analog signal to the local loop. The **tel set pcm_gain_level** command is used to set the gain level for the PCM codec for compensating signal loss in the local loop.

Syntax Description

1	Set gain level to -1 dB
2	Set gain level to 0 dB
3	Set gain level to +1 dB
4	Set gain level to +2 dB
5	Set gain level to +3 dB

Default

The default setting is -1 dB.

Note

The PCM gain level setting is only meaningful to FXO ports. It is not applicable to FXS ports.

tel set ring_freq {1|2|3|4}

Use the **tel set ring_freq** command to set the frequency of the ringer VIP uses to ring a FXS port.

Syntax Description

1	Set ring freq to 17 Hz
2	Set ring freq to 20 Hz
3	Set ring freq to 25 Hz
4	Set ring freq to 50 Hz

7.13 E & M Signaling Commands

E&M Common Signaling Configuration Commands

The E&M common signaling configuration commands are used to define common parameters used on all E&M interfaces, regardless of their mode of operation (Wink Start, Delay Start, or Immediate Start).

set port port em clear_conf_detect

This command is used to set the minimum duration of on-hook response on the M-lead that is required for clear confirm to be detected.

set port port em clear_conf_detect milliseconds

Syntax description

milliseconds

Time in milliseconds, ranging from 0 to 65535.

Default

5000

set port port em clear_conf_wait_max

This command is used to set the maximum duration to wait for an on-hook response on the M-lead after going on-hook on the E-lead.

set port port em clear_conf_wait_max milliseconds

Syntax description

milliseconds

Time in milliseconds, ranging from 0 to 65535.

Default

10000

set port port em clear_detect

This command is used to specify the period of time M-lead needs to be on-hook before call clearing is declared.

set port port em clear_detect milliseconds

Syntax description

milliseconds

Time in milliseconds, ranging from 0 to 65535.

Default

400

set port port em connected_min

This command is used to determine the minimum period of time (in milliseconds) that a connection will be maintained. If the remote end disconnects during this interval, it will be acknowledged only at the end of this interval.

set port port em connected_min milliseconds

Syntax description

milliseconds

Time in milliseconds, ranging from 0 to 65535.

Default

2000

set port *port* em dial_tone

This command is used to determine if dial tone should be generated on incoming calls.

set port *port* em dial_tone [on | off]

Syntax description

on	Generate dial tone.
off	Do not generate dial tone

Default

on

set port *port* em disable_hangup

This command is used to determine the time period (in milliseconds) a port will wait after hanging up a call before signaling that it is in a disabled state.

set port *port* em disable_hangup *milliseconds*

Syntax description

<i>milliseconds</i>	Time in milliseconds, ranging from 0 to 65535.
----------------------------	--

Default

2000

set port *port* em guard_all

This command is used to set the period after an aborted call when no incoming calls will be neither accepted nor outgoing calls initiated.

set port *port* em guard_all *milliseconds*

Syntax description

<i>milliseconds</i>	Time in milliseconds, ranging from 0 to 65535.
----------------------------	--

Default

400

set port *port* em guard_out

This command is used to set an additional period of time after guard_all when incoming calls will be accepted but outgoing calls will not be initiated for aborted call.

`set port port em guard_all milliseconds`

Syntax description

milliseconds

Time in milliseconds, ranging from 0 to 65535.

Default

400

`set port port em offhook_db`

This command is used to set the off-hook debounce interval, in milliseconds.

`set port port em offhook_db milliseconds`

Syntax description

milliseconds

Time in milliseconds, ranging from 0 to 65535.

Default

50

`set port port em onhook_db`

This command is used to set the on-hook debounce interval, in milliseconds.

`set port port em onhook_db milliseconds`

Syntax description

milliseconds

Time in milliseconds, ranging from 0 to 65535.

Default

50

`set port port em size_detect`

This command is used to specify the period of time the M-lead needs to be off-hook before an incoming call is declared.

`set port port em size_detect milliseconds`

Syntax description

milliseconds

Time in milliseconds, ranging from 0 to 65535.

Default

150

E&M Immediate Start Signaling Configuration Commands

The E&M immediate start signaling configuration commands are used to define parameters specific to E&M immediate start interface. These commands apply to E&M Immediate Start signaling protocol only.

set port *port* emi glare_report

This command is used to set a time period during which, if glare is detected, the interface will stay off-hook and generate congestion tone.

set port *port* emi glare_report *milliseconds*

Syntax description

milliseconds

Time in milliseconds, ranging from 0 to 65535.

Default

5000

set port *port* emi wait_dsp_ready

This command is used to set a time period (in milliseconds) to wait for the DSP software to be ready before digit collection can be enabled. If glare is detected during this period, the interface will stay offhook and generate congestion tone.

set port *port* emi glare_report *milliseconds*

Syntax description

milliseconds

Time in milliseconds, ranging from 0 to 65535.

Default

200

E&M Delay Start Signaling Configuration Commands

The E&M delay start signaling configuration commands are used to define parameters specific to E&M delay start interface. These commands apply to E&M Delay Start signaling protocol only.

set port *port* emd in_delay_max

This command is used to set the maximum duration of the delay signal response to the Seize Detect (of incoming calls) on the M-lead.

set port *port* emd in_delay_max *milliseconds*

Syntax description

milliseconds

Time in milliseconds, ranging from 0 to 65535.

Default

2500

set port port emd in_delay_min

This command is used to set the minimum duration of the delay signal response to the seize detect (of incoming calls) on the M-lead.

set port port emd in_delay_min milliseconds

Syntax description**milliseconds**

Time in milliseconds, ranging from 0 to 65535.

Default

200

set port port emd in_digit_ign

This command is used to set the period of time, after completing the delay signal, before the digits will be accepted on incoming calls.

set port port emd in_digit_ign milliseconds

Syntax description**milliseconds**

Time in milliseconds, ranging from 0 to 65535.

Default

30

set port port emd out_delay_check

This command is used to set the period of time after going off-hook on the E-lead before checking the M-lead for the delay signal response. If the response is not seen at this time, the call setup process will continue immediately.

set port port emd out_delay_check milliseconds

Syntax description**milliseconds**

Time in milliseconds, ranging from 0 to 65535.

Default

170

set port port emd out_delay_dur_max

This command is used to set the maximum duration of the delay signal response on the M-lead for it to be detected on outgoing calls.

set port port emd out_delay_dur_max milliseconds

Syntax description

milliseconds	Time in milliseconds, ranging from 0 to 65535.
---------------------	--

Default

8000

set port port emd out_delay_dur_min

This command is used to set the minimum duration of the delay signal response on the M-lead for it to be detected on outgoing calls.

set port port emd out_delay_dur_min milliseconds

Syntax description

milliseconds	Time in milliseconds, ranging from 0 to 65535.
---------------------	--

Default

100

set port port emd out_intg_check

This command is used to set the Integrity Check mode. If On, the delay signal response is required from the PBX for outgoing calls. If Off, no Integrity Check is performed.

set port port emd in_digit_ign [on | off]

Syntax description

on	Perform Integrity Check
off	No Integrity Check is performed

Default

off

E&M Wink Start Signaling Configuration Commands

The E&M wink start signaling configuration commands are used to define parameters specific to E&M wink start interface. These commands apply to E&M Wink Start signaling protocol only.

set port port emw in_wink_digit_ignore

This command is used to specify the period of time that will be ignored after completing the wink and before digits will be accepted for incoming calls.

set port port emw in_wink_digit_ignore milliseconds

Syntax description**milliseconds**

Time in milliseconds, ranging from 0 to 65535.

Default

30

set port port emw in_wink_dur

This command is used to specify the duration of the wink signal on the E-lead for incoming calls.

set port port emw in_wink_dur milliseconds

Syntax description**milliseconds**

Time in milliseconds, ranging from 0 to 65535.

Default

200

set port port emw in_wink_wait_max

This command is used to set the maximum delay before beginning the wink on the E-lead after detecting a line seizure on the M-lead for an incoming call.

set port port emw in_wink_wait_max milliseconds

Syntax description**milliseconds**

Time in milliseconds, ranging from 0 to 65535.

Default

3000

set port port emw in_wink_wait_min

This command is used to set the minimum delay before beginning the wink on the E-lead after detecting a line seizure on the M-lead for an incoming call.

set port port emw in_wink_wait_min milliseconds

Syntax description**milliseconds**

Time in milliseconds, ranging from 0 to 65535.

Default

150

set port port emw out_wink_dur_max

This command is used to set the maximum duration of the wink response on the M-lead for it to be detected.

`set port port emw out_wink_dur_max milliseconds`

Syntax description**milliseconds**

Time in milliseconds, ranging from 0 to 65535.

Default

800

`set port port emw out_wink_dur_min`

This command is used to set the minimum duration of the wink response on the M-lead for it to be detected.

`set port port emw out_wink_dur_min milliseconds`

Syntax description**milliseconds**

Time in milliseconds, ranging from 0 to 65535.

Default

100

`set port port emw out_wink_wait_max`

This command is used to specify the maximum time to wait for a wink response on the M-lead after going offhook on the E-lead. If the period is exceeded, the interface will declare an error condition and abort the (outgoing) call attempt.

`set port port emw out_wink_wait_max milliseconds`

Syntax description**milliseconds**

Time in milliseconds, ranging from 0 to 65535.

Default

8000

7.14 Obsolete Commands

Some of the CLI commands previously supported by version 2.0x software or older versions are no longer supported. The following table lists the obsolete commands and commands CLI current supports that serve the equivalent functions:

Obsolete Command	New Command
activate	config activate
commit	config store
flash clean config	config erase
flash clean dial_plan	atpm erase

Chapter 8 Upgrading and resetting VIP

VIP series (VIP-000/200/400) are able to have system functionality enhancement via software upgrade. This must be operated in upgrade mode. In firmware upgrade mode, limited commands allow users to read new revision codes from a remote TFTP server and write into the built-in flash non-volatile storage.

To enter download mode, either Telnet or Console (RS-232) connection can take the job, and a TFTP server is required by VIP to complete firmware upgrade process.

8.1 Firmware upgrade

To switch from normal operation mode to download mode, use the **download** CLI command.

```
ITG> download <Enter>
```

Note: To be able to switch to download mode from Telnet session, TFTP loader on VIP must be version 3.00 or higher. To upgrade to firmware version 3.03 or above, bootloader version 4.01 or above is required.

After **download** command is inserted, VIP will terminate all on-going calls, reset and enter firmware download mode. If you enter download mode from Telnet session. The Telnet session will be terminated too. You need to re-connect to VIP from Telnet client to be able to access the firmware download mode.

Before going any further, please note: **NEVER, NEVER TURN OFF POWER** while firmware upgrade is working in progress!! (**Please ensure power supply is stable before firmware upgrade is executed.**)

TFTP server is required to complete VIP series firmware upgrade process; there are various TFTP server software on the market, please utilize the existing software or find a new one on the net to complete upgrade process. (In this chapter, 3CDeamon TFTP server was installed for demonstration.)

TCP/IP Configuration:

Computer installed with TFTP server: 192.168.0.7

VIP: 192.168.0.1

Note: If a Telnet connection is built behind NAT environment, **TCP port 69 MUST** be reserved for data communication.

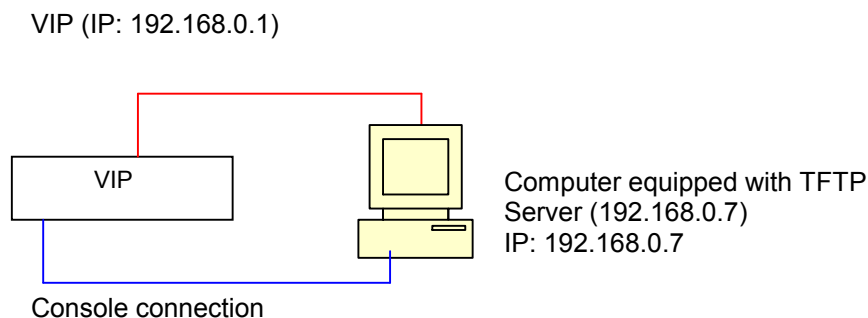

TFTP server configuration

1. Execute TFTP server program, assign firmware file location, and save the path if necessary. (In this sample datagram, the file is assigned in c:\) (This part might vary on different kind of TFTP server.)

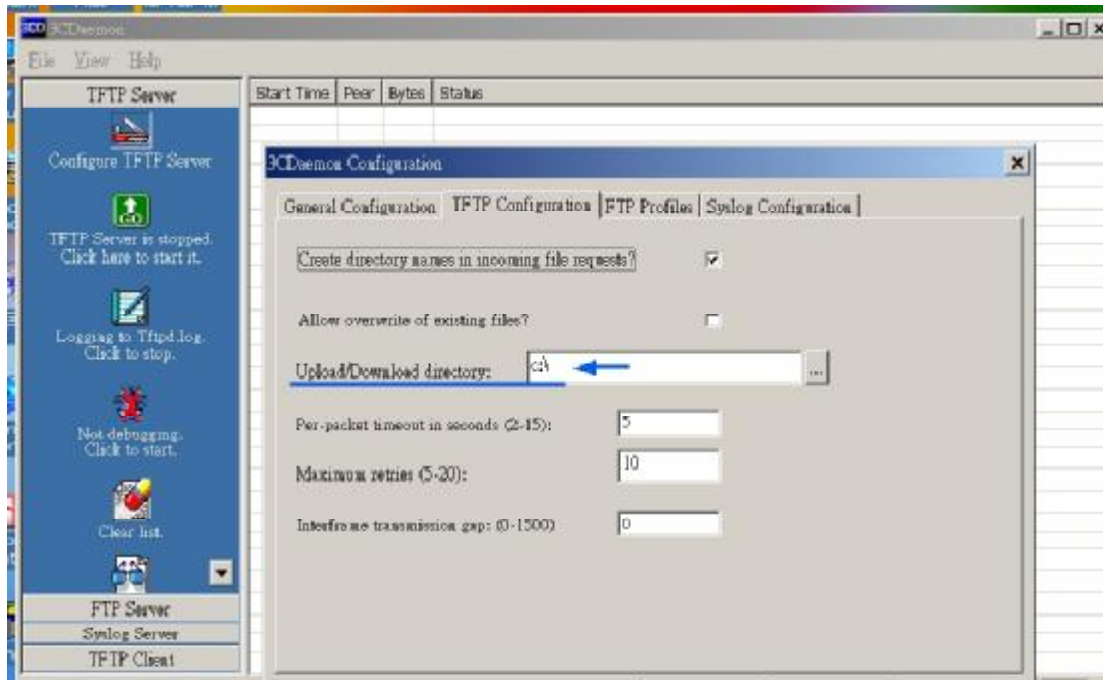

2. Allocate VIP firmware file in the directory, and apply the modification (if required).

Note: TCP port 69 is required for TFTP access.

VIP configuration:

Telnet session

- a) Under Telnet firmware download mode, the user name: **eitg**; password: **123** (password may vary because of user's configuration) is used for logging on VIP
- b) Under ITG> prompt, insert command: **download** to enter VIP firmware upgrade mode.
- c) Insert command: **start** and answer questions on screen to proceed firmware upgrade.
- d) When VIP prompts downloading firmware file into EEPROM, insert **y** to continue.
- e) Wait till firmware is fully loaded into VIP, insert **quit** to leave firmware upgrade mode and answer **y** to reboot machine when VIP prompts for restart.

```
ITG>download
===== WARNING =====
* Entering download mode will hang up all telephone connections *
* and all the configuration settings will lose. *
* Be certain all the configuration settings have been saved. *
=====

Do you want to enter download mode now (y/n)? [n] y

Boot loader V4.12
Loading TFTP loader.....
** Internet Telephony Gateway TFTP Loader Ver 4.10 **
EITGLoader>start

IP address of the TFTP server? [192.168.0.254] 192.168.0.7
File name? it4p315.imz

Starting download file: it4p315.imz
.....
Download complete, file size = 833004
Application code downloaded successfully
Do you want to write downloaded image to flash EEPROM (y/n)? [y] y
Press <Enter> to start flash EEPROM programming
Flash EPROM programming on-going, BE CERTAIN NOT TO TURN POWER OFF...
Flash sector no. 4 write done
Flash sector no. 5 write done
Flash sector no. 6 write done
Flash sector no. 7 write done
Flash sector no. 8 write done
Flash sector no. 9 write done
Flash sector no. 10 write done
Flash sector no. 11 write done
Flash sector no. 12 write done
Flash sector no. 13 write done
Flash sector no. 14 write done
Flash sector no. 15 write done
Flash sector no. 16 write done
Flash EEPROM programming completed
All sectors programmed successfully
Download another file (y/n)? [n] n
EITGLoader>quit

Do you want to restart the system now (y/n)? [n] y
```

Console session

- a) Connect VIP through the 9-pin RS232 female console (No password required)
Under ITG> prompt, insert command: **download** to enter VIP firmware upgrade mode.
- b) Insert command: **start** and answer questions on screen to proceed firmware upgrade.
- c) When VIP prompts downloading firmware file into EEPROM, insert **y** to continue.
- d) Wait till firmware is fully loaded into VIP, insert **quit** to leave firmware upgrade mode and answer **y** to reboot machine when VIP prompts for restart.

```
ITG>download
===== WARNING =====
* Entering download mode will hang up all telephone connections *
* and all the configuration settings will lose. *
* Be certain all the configuration settings have been saved. *
=====

Do you want to enter download mode now (y/n)? [n] y

Boot loader V4.12
Loading TFTP loader.....
** Internet Telephony Gateway TFTP Loader Ver 4.10 **
EITGLoader>start

IP address of the TFTP server? [192.168.0.254] 192.168.0.7
File name? it4p315.imz

Starting download file: it4p315.imz
.....
Download complete, file size = 833004
Application code downloaded successfully
Do you want to write downloaded image to flash EEPROM (y/n)? [y] y
Press <Enter> to start flash EEPROM programming
Flash EPROM programming on-going, BE CERTAIN NOT TO TURN POWER OFF...
Flash sector no. 4 write done
Flash sector no. 5 write done
Flash sector no. 6 write done
Flash sector no. 7 write done
Flash sector no. 8 write done
Flash sector no. 9 write done
Flash sector no. 10 write done
Flash sector no. 11 write done
Flash sector no. 12 write done
Flash sector no. 13 write done
Flash sector no. 14 write done
Flash sector no. 15 write done
Flash sector no. 16 write done
Flash EEPROM programming completed
All sectors programmed successfully
Download another file (y/n)? [n] n
EITGLoader>quit

Do you want to restart the system now (y/n)? [n] y
```

Trouble Shooting Tips

If following error (**TFTP timeout error**) occurs:

```
** Internet Telephony Gateway TFTP Loader Ver 4.10 **
EITGLoader>start

IP address of the TFTP server? [192.168.0.7]
File name? it4p315.img

Starting download file: it4p315.imz
TFTP device open failed. - TFTP server timeout while waiting for a response from the client.
Download another file (y/n)? [n]
```

Possibility:

- a) Network connection is not correctly configured
 - check if cable is securely connected.
 - check if TFTP server IP address is correctly configured
 - check if TCP port 69 is available for TFTP connection
 - if firmware upgrade is processed remotely, a fast connection between VIP and TFTP server is required (ping response time <300 ms)

During firmware upgrade, "**protocol error detected**" displays on the screen.

```
** Internet Telephony Gateway TFTP Loader Ver 4.10 **
EITGLoader>start

IP address of the TFTP server? [192.168.0.7]
File name? it4p315.img

Starting download file: it4p315.img
TFTP device open failed. - Protocol error detected.
Download another file (y/n)? [n]
```

- a) In most circumstances, this error occurs while requested firmware file cannot be found on TFTP server.

Possibility:

- check if the firmware file is correctly located in assigned folder.
- check if TFTP server supports long file name format.
- check if firmware file name is correctly inserted
- check system log on TFTP server if there is error message for trouble shooting.

8.2 CLI Commands in Download Mode

Under download mode, the CLI supports the following commands:

Command	Description
help	Display help screen
quit	Terminate download mode, switch to normal operation mode.
set	Change IP parameter
start	Start downloading code from TFTP server

The following section describes each of the commands.

help

The **help** command lists the top-level commands.

quit

The **quit** command is used to terminate the download mode and return to normal operation mode.

Syntax Description

This command has no arguments or keywords

Note

Switching mode from Telnet session will terminate current active session. You'll need to connect to VIP again to be able to access the CLI.

set ip *ip_addr*

Use the **set ip** command to assign a static IP address to VIP.

Syntax description

<i>ip_addr</i>	The IP address of VIP.
-----------------------	------------------------

Note

The new IP address will not take effect until VIP is reset.

set gateway *ip_addr*

Use the **set gateway** command to assign a default gateway (router) for VIP. The default gateway routes packet data outside of your IP subnet.

Syntax description

<i>ip_addr</i>	The IP address of the default gateway. Default value: 0.0.0.0
-----------------------	---

Note

The new setting will not take effect until VIP is reset.

set mask *ip_mask*

Use the **set mask** command to set the IP subnet mask for VIP.

Syntax description

<i>ip_mask</i>	The subnet mask of your network.
-----------------------	----------------------------------

Note

The new setting will not take effect until VIP is reset.

start

Use the **start** command to start downloading code from TFTP server. VIP will prompt you for the IP address of the TFTP server and the file to download.

8.3 Restore default configuration

If there is system re-organization, firmware upgrade or improper parameters are loaded in VIP-000/200/400, restoring factory default settings may help you to restore initial state of machine and restart configuration.

Following are steps loading VIP series default parameters:

Note: restore process in this session only can be applied to firmware version 3.xx)

System configuration default parameters

- Logon VIP via telnet or console connection, and insert command: **config erase**
- After this command, VIP pops up a warning message and prompts for confirmation.
- Press "y" to erase current system configuration parameters,
- Enter **net reset** to reboot and load the default system parameters into machine.
- Log on VIP, and insert command: **config store** to load factory default parameters into VIP.

A sample is attached below for reference.

```
ITG>config erase

The system configuration data will be erased from non-volatile storage permanently.

Are you sure to erase it (y/n)? [n] y
System configuration records erased from flash
ITG>net reset

===== WARNING =====
* Restarting the system will hang up all telephone connections *
* and all the configuration settings will lose. *
* Be certain all the configuration settings have been saved. *
=====

Do you want to restart the system now (y/n)? [n] y

Boot loader V4.12
Mem 16b 16M
Loading application code.....

***** Internet Telephony Gateway (PLA) Version 3.xx *****

***** Hardware Configuration *****
Flash: type-MX29L1611 32 sectors 64 KB/sector
RAM: 8 MB 512K x 16
LAN: auto-negotiation on-going. Link DOWN
TIM slot A: type-FXO2S2 DSP-C5409 codec-PEB2466 Diag-OK
*****

ITG>config store

OK
ITG>
```

Dialplan configuration default parameters:

- a) Log on VIP via telnet or console connection.
- b) At the ITG prompt, insert following commands:
 ITG>**atpm erase**
 ITG>**net reset** (Answer "y" to reboot machine.)
 After rebooting, logon VIP. At the ITG> prompt, insert: **atpm store** to restore Dialplan default value into VIP.
 A sample is attached below for reference.

```

ITG>atpm erase

The dial plan will be erased from non-volatile storage permanently.

Are you sure to erase it (y/n)? [n] y
Dial plan erased from flash
OK
ITG>net reset

===== WARNING =====
* Restarting the system will hang up all telephone connections      *
* and all the configuration settings will lose.                      *
* Be certain all the configuration settings have been saved.        *
=====
Do you want to restart the system now (y/n)? [n] y

Boot loader V4.12
Mem 16b 16M
Loading application
code.....

***** Internet Telephony Gateway (PLA) Version 3.xx *****

***** Hardware Configuration *****
Flash:  type-MX29L1611 32 sectors 64 KB/sector
RAM:    8 MB 512K x 16
LAN:    auto-negotiation on-going. Link DOWN
TIM slot A: type-FXO2S2 DSP-C5409 codec-PEB2466 Diag-OK
*****

ITG>No dial plan info can be found in the Flash, the default dial plan is used but NOT saved.
OK

ITG>atpm store

OK

```

Appendix A Technical Specifications

A.1 VIP Technical Specifications

Telephony Interface Module support	VIP-000: 4 ports loop start FXO 4 ports loop start FXS (Up to two modules per unit) VIP-200: 2 ports loop start FXS VIP-400: 2 ports loop start FXO, 2 ports loop start FXS
Network Interface Ports	1 10/100Base-T, auto sensing, RJ45
Voice codec support	G.711 PCM 64kbps (A-law and μ -law) G.723.1A ACELP/M-MLQ (5.3, 6.3kbps) G.729AB CS-ACELP (8kbps)
Fax	ITU-T V.21, V.27ter, V.29, V.33 and V.17
Fax over IP protocol	T.38 Proprietary low bandwidth protocol
Echo cancellation	G.168 compliant, 16 ms tail length
Simultaneous connection	VIP-000: 8 channels voice/fax VIP-200: 2 channels voice/fax VIP-400: 4 channels voice/fax
Voice processing	Voice activity detection DTMF detection/generation Echo cancellation Comfort noise generation Call progress detection Gain control
Call control	H.323
Management	Built HTTP server allowing management from web browser Command line interface allowing management from VT-100 terminal or Telnet client
Software upgrade	Flash memory and built-in TFTP allowing software upgrade via network
Power	VIP-000: 90-240 VAC, 20 Watts, 50-60 Hz VIP-200/400: AC-to-DC power supply, 90-260 VAC, 50-60 Hz
Environmental	Operating temperature: 0° to 45° C (32° to 113° F) Storage temperature: -10° to 65° C (-4° to 149° F) Humidity: 10% to 85% (non-condensing)

Dimension (L x W x D)	VIP-000: 44 x 445 x 275 (mm) VIP-200: 150 x 220x 44 (mm) VIP-400: 150 x 220x 44 (mm)
Compliances	EMI FCC Part 15 Class A EN55022 Class A (CISPR-22 Class A) VCCI Class A CE Safety UL 1950 CE
Mounting	VIP-000: Desktop or 19" mounting VIP-200: Desktop VIP-400: Desktop

A.2 FXO Card Technical Specifications

Signaling:	Loop Start / DTMF
No. of channels:	4
Interface Connectors:	4 RJ-11 2-pin modular jacks.
Line Impedance :	600 Ω 900 Ω
Insertion Loss:	2 dB nominal.
Frequency Response:	300Hz ~ 3400Hz +/- 2dB w.r.t. 1004Hz.
Return Loss:	≥ 18 dB
Input Level adjustment:	-6 dB to +6 dB
Output Attenuation:	0 dB to 13 dB
Longitudinal Balance:	≥ 45 dB

A.3 FXS Card Technical Specifications

Signaling:	Loop Start / DTMF
No. of channels:	4
Interface Connectors:	4 RJ-11 2-pin modular jacks.
Line Impedance :	600 Ω 900 Ω
Insertion Loss:	2 dB nominal.
Frequency Response:	300Hz ~ 3400Hz +/- 2dB w.r.t. 1004Hz.
Return Loss:	≥ 18 dB
Input Level adjustment:	-6 dB to +6 dB
Output Attenuation:	0 dB to 13 dB
Longitudinal Balance:	≥ 45 dB
Loop Current:	25mA nominal
Ring Voltage:	50Vrms Nominal
Ringing Tone:	16.67Hz, 20Hz(default), 25Hz or 50Hz

A.4 E&M Card Technical Specifications

Type V, four wires

A.5 Console Port

The console port uses a DB-9 RS-232 connector. The supplied straight-through RS-232 cable connects the console port of VIP to a console PC or terminal. Pinout for the port is described in the following table.

DB-9 pin	Signal
1	Not connected
2	TxD
3	RxD
4	Not connected
5	Ground
6	Not connected
7	Not connected
8	Not connected
9	Not connected

A.6 LAN Port

The 10/100 LAN port use standard RJ-45 connector and Ethernet pinouts. The following diagram and table show the pinout on the port connector. When connecting the LAN port to switches or repeaters, you must use a straight-through cable.

RJ45 pin	Signal
1	RxD+
2	RxD-
3	TxD+
4	Not connected
5	Not connected
6	TxD-
7	Not connected
8	Not connected

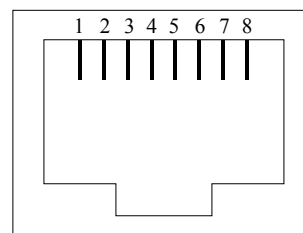

A.7 FXO Port Pin Assignments

The FXO Telephony Interface Module has 4 RJ11C/W modular jacks. The following diagram and table show the assignments of the pin for the RJ11 port.

RJ-11 pin	Signal
1	Not connected
2	Tip
3	Ring
4	Not connected

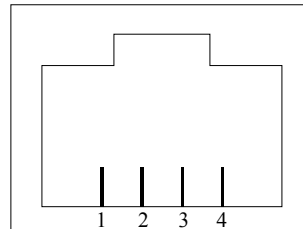

A.8 FXS Port Pin Assignments

The FXS Telephony Interface Module has 4 RJ11C/W modular jacks. The following diagram and table show the assignments of the pin for the RJ11 port.

RJ-11 pin	Signal
1	Not connected
2	Tip
3	Ring
4	Not connected

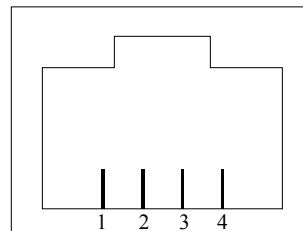

A.9 E&M Pin Assignment

The pin assignment for the current **E&M** (V2.0 and below) **supports typeV 4W only**. The description below only applies to V2.0 and below E&M line module.

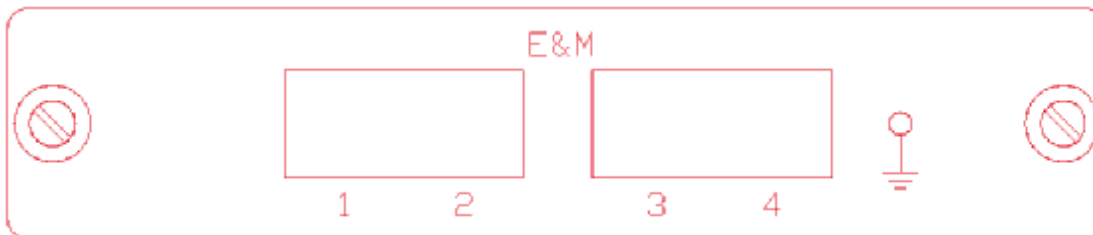

The pin assignment for each port starts from the left to the right
 The color-coding scheme is just a reference; it depends upon the cable used.
 And the I/P, O/P sense is from the line module side.

Pin No.	Color Scheme	Symbol	I/P, O/P sense
1	Brown	-	
2	Blue	M-lead	I/P for E&M
3	Yellow	RRing	4W RX Ring, I/P for E&M
4	Green	TRing	4W TX Ring, O/P for E&M
5	Red	TRing	4W TX Tip, O/P for E&M
6	Black	RTip	4W RX Ting, I/P for E&M
7	Orange	E-Lead	O/P for E&M
8	Grey	-	

Appendix B CLI Commands

B.1 Normal Mode Commands

Command	Description
atpm add	Add an entry to the address table
atpm adel	Delete an entry from the address table
atpm afind	Find and display an entry in the address table
atpm alist	Display all entries in the address table
atpm dadd	Add an entry to the destination table
atpm ddel	Delete an entry from the destination table
atpm dfind	Find and display an entry in the destination table
atpm dlist	Display all entries in the destination table
atpm hadd	Add an entry to the hunt group table
atpm hdel	Delete an entry from the hunt group table
atpm hfind	Find and display an entry in the hunt group table
atpm hlist	Display all entries in the hunt group table
atpm done	End the atpm table update session
atpm erase	Erase all atpm tables from NVS
atpm purge	Purge entries from atpm table(s)
atpm req	Start atpm table update session
atpm restore	Restore atpm tables from NVS
atpm store	Store atpm tables into NVS
atpm slist	Display atpm system parameters
atpm sys	Set atpm system parameters
config activate	Move the configuration from temporary area to active area.
config erase	Erase the configuration from NVS
config store	Store the active configuration data into NVS
clrscr	Clear screen
download	Switch to download mode
help	Display help screen

net reset	Reset the system
net set gateway	Set default gateway's IP address
net set http	Turn on/off HTTP server
net set ip	Set IP address
net set ip_preced	Set IP precedence bits
net set mask	Set IP subnet mask
net set speed	Select Ethernet link speed
net set user_pw	Set password
net show	Display IP parameters
net show hwstat	Display hardware status
ping	Send ICMP echo request to another host
show h323	Display H.323 parameter settings
show version	Show software versions
set h323	Set H.323 parameters
tel show pcm_gain_level	Display gain level setting of the PCM codec's receive channel.
tel show port	Display hook state for a telephony port
tel show ring_freq	Show ringer's frequency
tel set pcm_gain_level	Set gain level for the PCM codec's receive channel
tel set ring_freq	Set ringer's frequency

B.2 Download Mode Commands

Command	Description
Help	Display help screen
Quit	Switch to normal operation mode
set gateway	Set default gateway 's IP address
set ip	Set IP address
net set mask	Set IP subnet mask
start	Start downloading file

Appendix C Factory Default Settings

The following table lists the settings of certain parameters before VIP is shipped.

Parameter	Default Setting
Network	
IP address	192.168.0.1
IP subnet mask	255.255.255.0
Default gateway	0.0.0.0
IP precedence	0
Ethernet link speed	10/100 auto-negotiation
User ID for HTTP browser and Telnet client login	administrator
Password for HTTP browser and Telnet access login	123
User name for Telnet session in download mode	eitg
Password for Telnet session in download mode	123
HTTP server	On
Telnet server	On
Serial port (Fixed)	
Baud rate	19,200
Number of data bit	8
Parity check	None
Number of stop bit	1
Flow control	None
H.323	
h323 display_name	customer
h323 h245_term_type	60
h323 rtp_port_base	30,000
h323 out_fast_start	Off
h323 in_fast_start	Off
h323 h245_tunneling	Off
h323 cisco_t38	On
h323 callSignalPort	1720

h323 nat_call	On
h323 call_name	null
h323 local_alert	Off
h323 default_dtmf	H323 V2 Signal
h323 dns_ip	null
h323 gk_mode	Off
h323 h245_timeout	30000
h323 term_id	null
Voice codec	
Preferred voice codec	G.723 6.3kbps
TxVIF size (default voice codec=g.723)	192
RxVIF size (default voice codec=g.723)	192
VAD	Enabled
Playout nominal delay	120 ms
Playout maximum delay	240 ms
Playout minimum delay	0 ms
Fax tone detect	Enabled
Call Progress Tone detect	Enabled
Telephony	
PCM codec receiver gain for FXO ports	-1 dB
Ringer frequency for FXS ports	17 Hz

Appendix D Worksheets

D.1 IP Parameters

Consult your network manager to obtain a static IP address for VIP, and the information about the IP subnet mask and the default gateway for your network. Fill out the following work sheet before configuring VIP.

IP address	
IP subnet mask	
Default gateway	

D.2 ATPM Destination Table

Local Destinations

Each telephony ports of VIP must be assigned a unique destination ID. Fill out the worksheet for local destinations by designating each port a unique destination ID, then use the CLI command **atpm dadd *dest_id* port *port#*** for each entry in the worksheet to add it to the destination table. The *dest_id* in the command corresponds to the Destination ID in the worksheet, while the *port#* corresponds to the Port#. You may alternatively use the web browser to add local destinations to the destination table.

Port#	Mode	Destination ID
0	port	
1	port	
2	port	
3	port	
4	port	
5	port	
6	port	
7	port	

Remote Destinations

Each remote VIP to be reached must be assigned a unique destination ID. Obtain the IP addresses of VIP at remote sites and fill out the worksheet for remote destinations by designating each remote VIP a unique destination ID, then use the CLI command **atpm dadd dest_id h323 ip_addr [ip_port]** for each entry in the worksheet to add it to the destination table. The *dest_id* in the command corresponds to the Destination ID in the worksheet, the *ip_addr* corresponds to the Port#, the optional *ip_port* corresponds to the IP port. You may alternatively use the web browser to add remote destinations to the destination table.

IP address				IP port (optional)	Mode	Destination ID
.	.	.	.		H323	
.	.	.	.		H323	
.	.	.	.		H323	
.	.	.	.		H323	
.	.	.	.		H323	
.	.	.	.		H323	
.	.	.	.		H323	
.	.	.	.		H323	
.	.	.	.		H323	
.	.	.	.		H323	
.	.	.	.		H323	
.	.	.	.		H323	
.	.	.	.		H323	
.	.	.	.		H323	
.	.	.	.		H323	
.	.	.	.		H323	

D.3 ATPM Hunt Group Table

Several destinations may be grouped together to form a hunt group. When an incoming phone number matches the phone number of the hunt group, VIP attempts to terminate the call at each of the destinations in the hunt group one at a time until a call is successfully completed. Plan how destinations are to be grouped and fill out the hunt table worksheet, then use the CLI command **atpm hadd *hunt_group_id* *hunt_type* *dest_id* ...** for each entry in the worksheet to add it to the hunt group table. The *hunt_group_id* in the command corresponds to the Hunt Group ID in the worksheet, the *hunt_type* corresponds to the Hunt Type (1 or 2), the *dest_id* ... corresponds to the List of Destination IDs. You may alternatively use the web browser to add hunt groups to the hunt group table.

Hunt Group ID	Hunt Type		List of Destination IDs
	1	2	

D.4 ATPM Address Table

Each phone number to be recognized by VIP, must have its first digits match an entry in the address table. Fill out the address table worksheet and use the CLI command

atpm aadd tel# min_digits max_digits hunt_group_id prefix_strip_len [prefix#] to add each entry in the worksheet to the address table. The *tel#* in the command corresponds to the Digits to Match in the worksheet, the *min_digits* corresponds to the Min. # of Digits to Collect, the *max_digits* corresponds to Max. # of Digits to Collect, the *hunt_group_id* corresponds to the Hunt Group, the *prefix_strip_len* correspond to No. of Digits to Strip and the *prefix#* corresponds to the Prefix String. You may alternatively use the web browser to add telephone numbers to the address table.

Digits to Match	Min. # of Digits to Collect	Max. # of Digits to Collect	Hunt Group	No. of Digits to Strip	Prefix String

Index

<i>A</i>	
ATPM	7
<i>C</i>	
CNG	1
Concepts	7
<i>D</i>	
desktop	5
destination	7
dial plan	8
DTMF	7
DTMF relay.....	9, 22
<i>F</i>	
Features	1
Front Panel.....	2
Front Panel.....	2
<i>G</i>	
Gateway	1
grounded wrist strap.....	5
<i>H</i>	
H.323.....	7
hunt group	8
<i>I</i>	
Installing	5
Internet Telephony Gateway....	1
IP1	
<i>K</i>	
KTS.....	1
<i>P</i>	
PBX	1
Protocols.....	1
<i>R</i>	
real-time.....	1
Rear Panel.....	3
Reset Button.....	3
RTOS.....	1
RTP	1
<i>T</i>	
telephony interface module	5
Telnet.....	11
TIM	3
<i>U</i>	
Upgrading VIP	67
<i>V</i>	
VAD	1
VoIP	1